













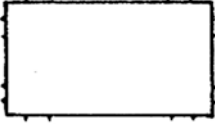



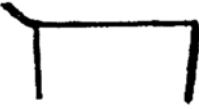



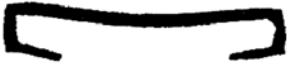





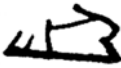





































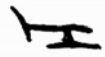



















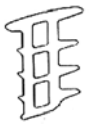

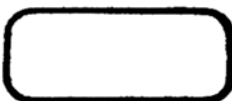





# CATÁLOGO GENERAL 2010

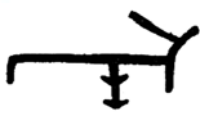





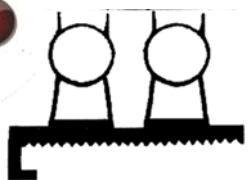









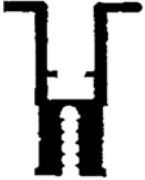

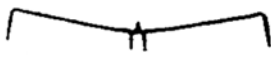















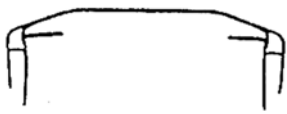

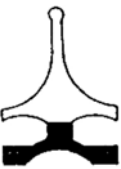
			
E-1 FL	E-2 FL	E-3 FL	E-4 FL
			
E-5 FL	E-6 RG	E-7 RG	E-8 FL (l.a.)
			
E-9 RG+FL	E-10 RG+FL	E-11 FL	E-12 RG+FL
			
E-13 FL	E-14 FL	E-15 FL	E-16 RG+FL
			
E-17 RG	E-18 FL	E-19 FL	E-20 FL
			
E-21 FL	E-22 FL (pe)	E-23 RG+FL	E-24 RG
			
E-25 RG	E-26 RG	E-27 FL	E-28 FL
			
E-29 FL	E-30 RG+FL	E-31 RG+FL	E-32 RG+FL













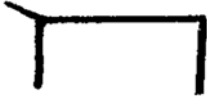



















			
E-33	FL	E-34	EPDM o FL
			
E-37	FL	E-38	FL
			
E-41	FL	E-42	FL
			
E-45	RG	E-46	FL
			
E-49	SEMI-RG	E-50	FL (pe)
			
E-53	POLICARB.	E-54	RG+FL
			
E-57	RG+FL	E-58	FL
			
E-61	FL	E-62	FL
		E-63	FL
		E-64	FL

















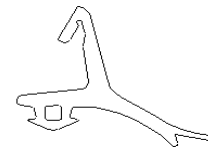









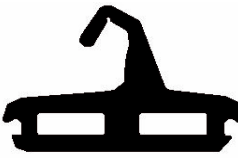



			
E-65	RG+FL	E-66	FL
			
E-69	RG+FL	E-70	RG
			
E-73	RG	E-74	FL
			
E-77	FL	E-78	RG
			
E-81	FL	E-82	RG+FL
			
E-85	FL	E-86	RG+FL
			
E-90	RG	E-91	RG
			
E-94	RG+FL	E-95	RG+FL



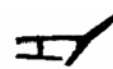
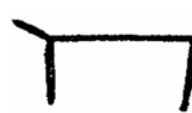































			
E-98 SEMI-RG	E-99 FL	E-100 RG	E-101 RG
			
E-102 RG	E-103 RG	E-104 RG	E-105 FL
			
E-106 FL	E-107 RG	E-108 SEMI-RG	E-109 POLICARB.
			
E-110 POLICARB.	E-111 FL	E-112 RG	E-113 FL
			
E-114 RG+FL	E-115 RG	E-116 RG	E-117 FL
			
E-118 RG	E-119 RG	E-120 RG	E-121 RG
			
E-122 RG+FL	E-123 RG+FL	E-124 RG+FL	E-125 RG+FL
			
E-126 RG+FL	E-127 RG+FL	E-128 RG+FL	E-129 RG+FL



















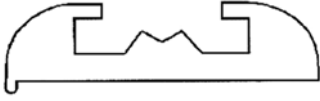













			
E-130	RG+FL	E-131	RG+FL
			
E-134	FL	E-135	RG+FL
			
E-138	FL	E-139	FL
			
E-142	RG+FL	E-143	RG+FL
			
E-146	FL	E-147	EPDM
			
E-150	EPDM	E-150/P	EPDM
			
E-153	EPDM	E-154	EPDM
			
E-157	EPDM	E-158	EPDM







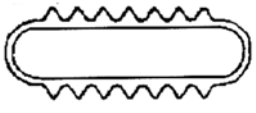

























			
E-161   EPDM	E-162   FL	E-163   RG+FL	E-164   RG+FL
			
E-165   EPDM	E-166   FL	E-167   EPDM	E-168   EPDM
			
E-169   EPDM	E-170   EPDM	E-171   FL	E-172   RG+FL
			
E-173   RG+FL	E-174   FL	E-175   EPDM	E-176   EPDM
			
E-177   EPDM	E-178   EPDM	E-179   EPDM	E-180   EPDM
			
E-181   EPDM	E-182   FL	E-183   FL	E-184   FL
			
E-185   RG+FL	E-186   RG+FL	E-187   RG+FL	E-188   FL
			
E-189   FL	E-190   RG+FL	E-191   RG+FL	E-192   FL



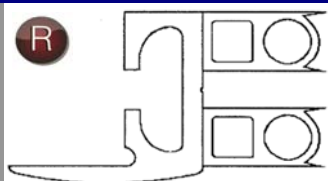









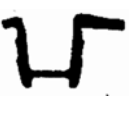

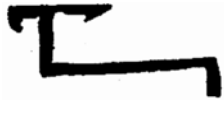







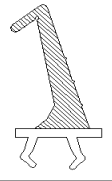
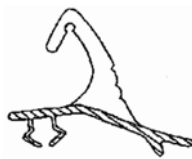

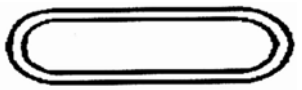





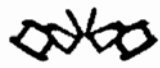

 E-193	EPDM	 E-194	FL	 E-195	FL	 E-196	EPDM
 E-197	FL	 E-198	EPDM	 E-199	FL	 E-200	EPDM
 E-201	FL	 E-202	EPDM	 E-203	FL	 E-204	EPDM
 E-205	EPDM	 E-206	FL	 E-207	FL	 E-208	RG+FL
 E-209	RG+FL	 E-210	SEMI-RG	 E-211	FL	 E-212	EPDM
 E-213	EPDM	 E-214	EPDM	 E-215	EPDM	 E-216	EPDM
 E-217	EPDM	 E-218	EPDM	 E-219	EPDM	 E-220	EPDM
 E-221	EPDM	 E-222	RG+FL	 E-223	FL	 E-224	RG+FL

















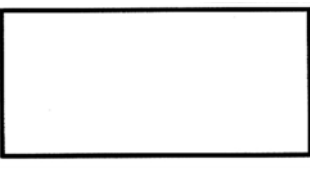
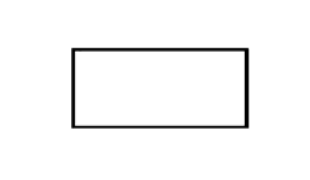
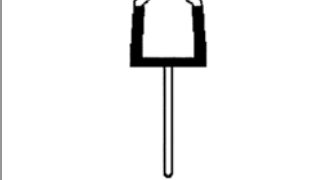

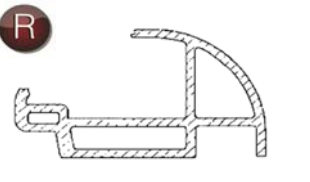



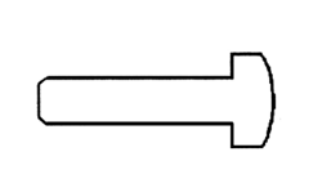



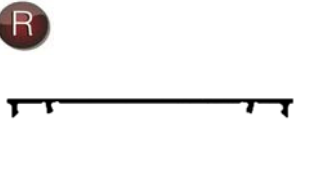
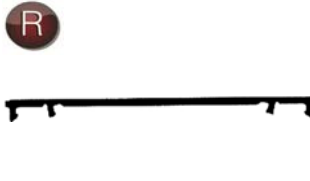

			
E-225 EPDM	E-226 RG	E-227 FL	E-228 RG+FL
			
E-229 EPDM	E-230 EPDM	E-231 SEMI-RG	E-232 FL
			
E-233 (ad)-RG+FL	E-234 EPDM	E-235 EPDM	E-236 EPDM
			
E-237 EPDM	E-238 EPDM	E-239 EPDM	E-240 EPDM
			
E-241 EPDM	E-242 EPDM	E-243 EPDM	E-244 EPDM
			
E-245 EPDM	E-246 EPDM	E-247 EPDM	E-248 EPDM
			
E-249 EPDM	E-250 EPDM	E-251 EPDM	E-252 EPDM
			
E-253 EPDM	E-254 SILICONA	E-255 EPDM	E-256 EPDM

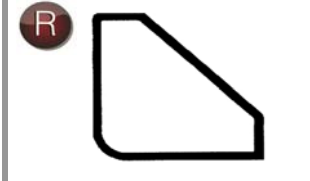
			
E-257 EPDM	E-258 EPDM	E-259 EPDM	E-260 EPDM
		 R	 R
E-261 EPDM	E-262 FL	E-263 EPDM	E-264 EPDM
 R			
E-265 RG	E-266 RG+FL	E-267 RG	E-268 EPDM ad
			
E-269 FL	E-270 EPDM	E-271 EPDM	E-272 EPDM
			
E-273 SEMI-RG	E-274 SEMI-RG	E-275 RG+FL	E-276 EPDM
		 R	
E-277 EPDM	E-278 EPDM	E-279 FL+FK	E-280 EPDM
		 R	 R
E-281 RG+FL+FK	E-282 SEMI-RG	E-283 RG+FL	E-284 RG
	 R		
E-285 EPDM	E-286 RG	E-287 EPDM ad	E-288 RG+FL

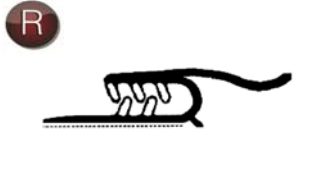





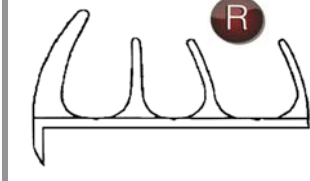























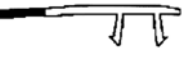

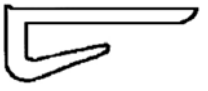

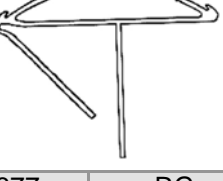





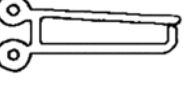



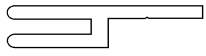











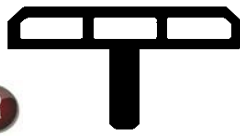







 E-289	 E-290	 E-291	 E-292
RG	RG	RG	FL
 E-293	 E-294	 E-295	 E-296
EPDM	FL	EPDM	EPDM
 E-297	 E-298	 E-299	 E-300
EPDM	RG+FL	RG+FL	RG+FL
 E-301	 E-302	 E-303	 E-304
RG+FL	SILICONA	TIJERAS	FL
 E-305	 E-306	 E-307	 E-308
RG+FL	RG+FL	FL	EPDM
 E-309	 E-310	 E-311	 E-312
EPDM	FL	SILICONA	EPDM
 E-313	 E-314	 E-315	 E-316
FL	EPDM	EPDM	EPDM
 E-317	 E-318	 E-319	 E-320
EPDM	EPDM	EPDM	SEMI-RG

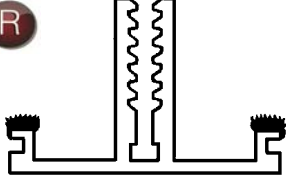





























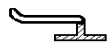

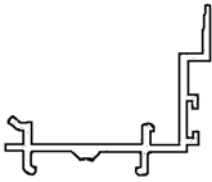
			
E-321 FL	E-322 EPDM	E-323 EPDM	E-324 RG
			
E-325 SILICONA	E-326 SILICONA	E-327 RG+FL	E-328 RG+FL
			
E-329 RG	E-330 POLICARB.	E-331 RG+FL	E-332 POLICARB.
			
E-333 FL	E-334 SEMI-RG	E-335 EPDM	E-336 EPDM
			
E-337 EPDM	E-338 RG	E-339 RG	E-340 EPDM
			
E-341 RG	E-342 RG	E-343 EPDM	E-344 RG
			
E-345 EPDM	E-346 RG+FL	E-347 SEMI-RG	E-348 EPDM
			
E-349 EPDM	E-350 EPDM	E-351 RG	E-352 RG+FL

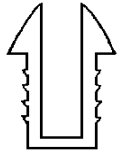

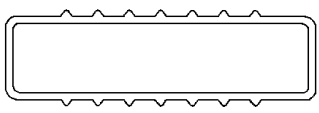
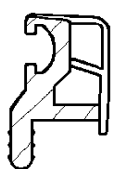
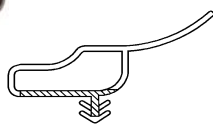









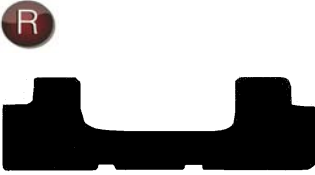
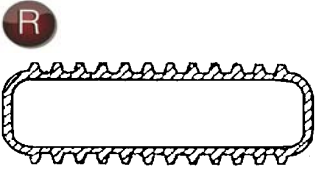

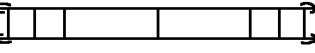
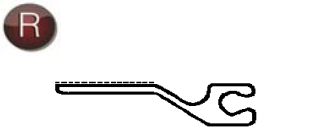

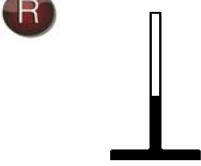











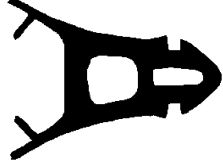

			
E-353 EPDM	E-354 EPDM	E-355 EPDM	E-356 EPDM
			
E-357 SEMI-RG	E-358 FL	E-359 RG	E-360 FL
			
E-361 EPDM	E-362 EPDM	E-363 FL	E-364 EPDM
			
E-365 EPDM	E-366 ESPUMADO	E-367 EPDM	E-368 FL
			
E-369 EPDM	E-370 EPDM	E-371 RG	E-372 RG
			
E-373 RG+FL	E-374 EPDM	E-375 EPDM	E-376 RG+FL
			
E-377 RG	E-378 FL	E-379 RG+CA	E-380 RG+CA
			
E-381 EPDM	E-382 EPDM	E-383 RG	E-384 RG

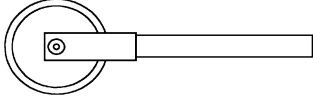
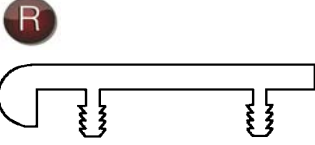
 E-385	 E-386	 E-387	 E-388
RG	RG	RG	EPDM
 E-389	 E-390	 E-391	 E-392
EPDM	EPDM	EPDM	EPDM
 E-393	 E-394	 E-395	 E-396
RG	CAUCHO	FL	RG+FL
 E-397	 E-398	 E-399	 E-400
RG+RG	RG	EPDM	EPDM
 E-401	 E-402	 E-403	 E-404
EPDM	POLIC.	RG+FL	FL
 E-405	 E-406	 E-407	 E-408
EPDM	EPDM	FL	SEMI-RG
 E-409	 E-410	 E-411	 E-412
RG+FL	EPDM	FL	FL
 E-413	 E-414	 E-415	 E-416
FL	RG+CA	RG	RG













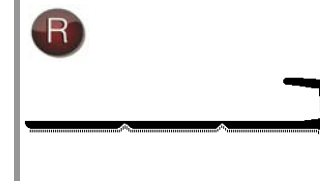

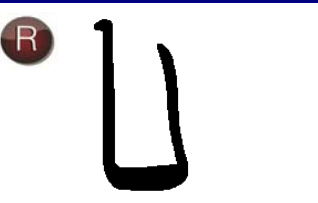
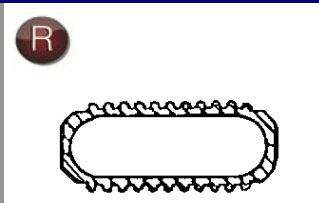
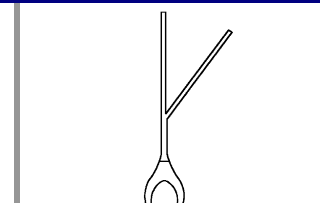

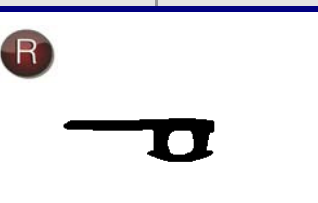
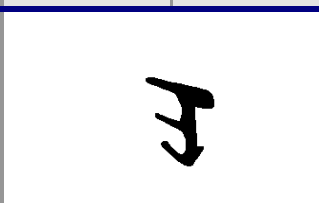
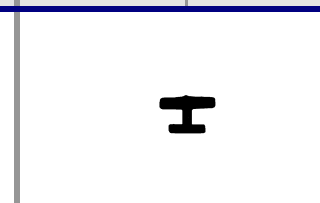
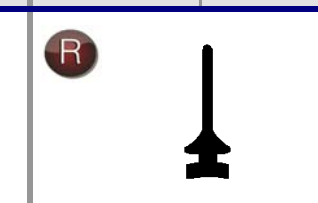
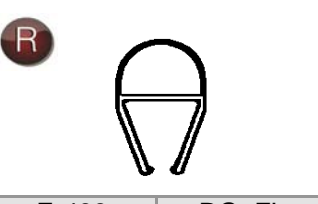
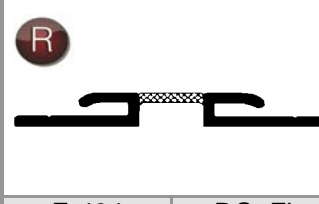
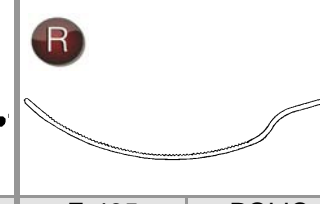
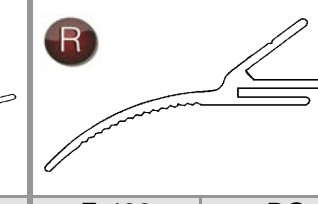
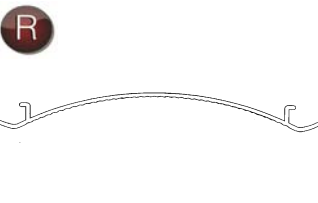
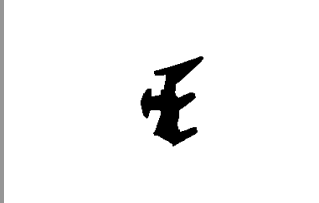

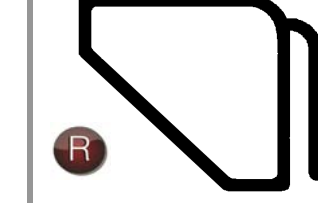

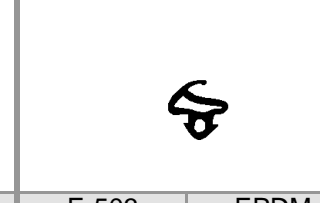
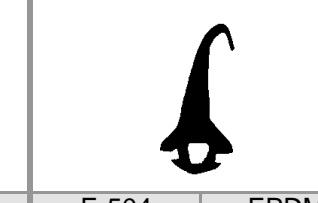
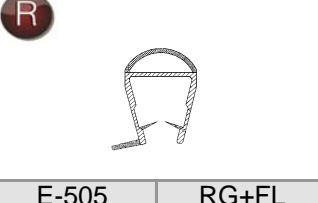
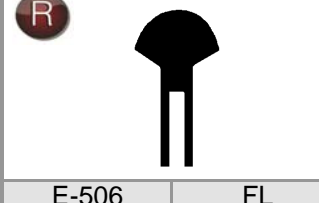

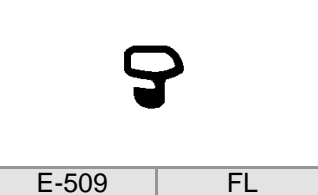
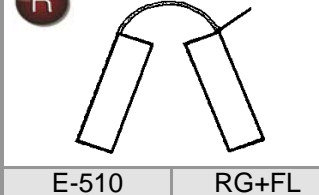
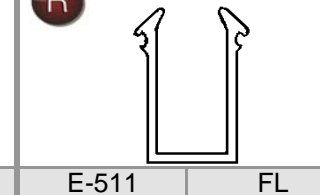
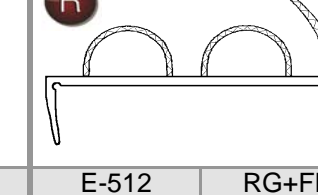









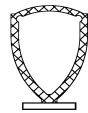
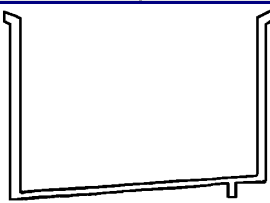
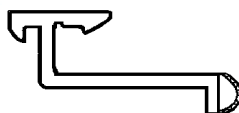
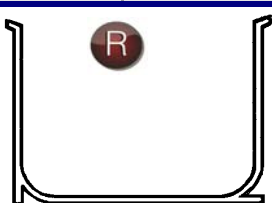

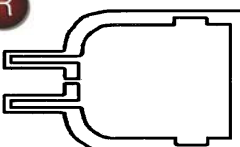
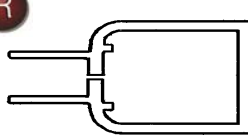

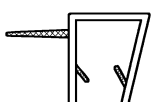
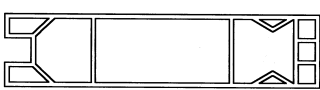

			
E-417 EPDM	E-418 FL (pe)	E-419 FL (pe)	E-420 FL
			
E-421 RG	E-422 FL	E-423 FL + PE	E-424 FL + PE
			
E-425 EPDM	E-426 EPDM	E-427 RG+CA	E-428 RG+CA
			
E-429 FL	E-430 RG	E-431 EPDM	E-432 EPDM
			
E-433 FL	E-434 RG+FL	E-435 RG+FL	E-436 FL
			
E-437 RG	E-438 RG+FL	E-439 FL	E-440 EPDM
			
E-441 SILICONA	E-442 RG+FL	E-443 RG+FL	E-444 EPDM
			
E-445 EPDM	E-446 EPDM	E-447 EPDM	E-448 EPDM



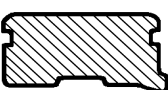

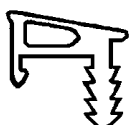











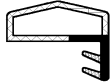

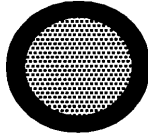

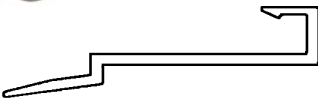
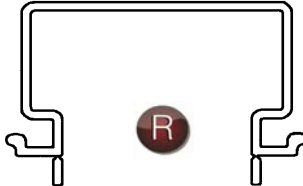
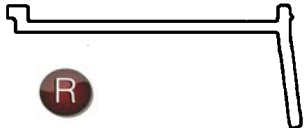
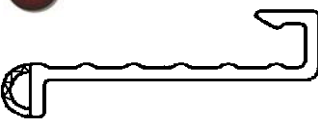
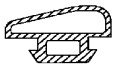

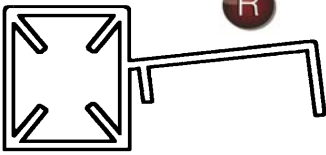

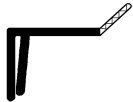



 E-449 EPDM	 E-450 SILICONA	 E-451 COLA VULC.	 E-452 RG
 E-453 RG+ADH	 E-454 FL	 E-455 RG+CA	 E-456 FL
 E-457 EPDM	 E-458 EPDM	 E-459 EPDM	 E-460 EPDM
 E-461 EPDM	 E-462 EPDM	 E-463 EPDM	 E-464 EPDM
 E-465 EPDM	 E-466 EPDM	 E-467 EPDM	 E-468 EPDM
 E-469 FL	 E-470 EPDM	 E-471 FL	 E-472 ROLINA
 E-473 SEMI-RIG	 E-474 RG	 E-475 RG	 E-476 RG
 E-477 RG	 E-478 SEMI-RG	 E-479 EPDM	 E-480 EPDM













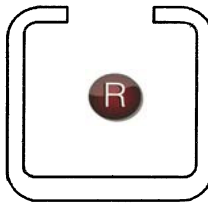
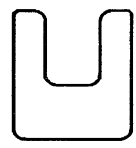
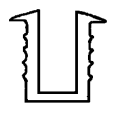

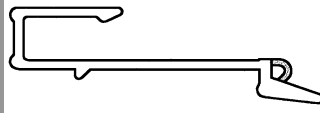

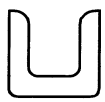
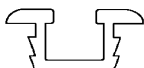
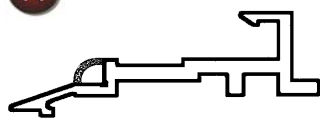





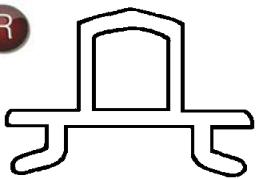
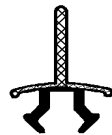





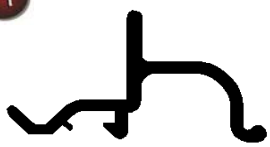
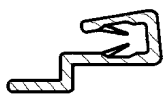
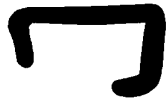
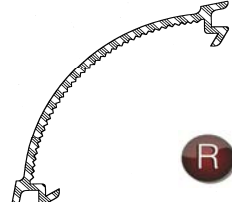







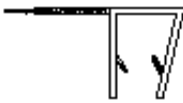







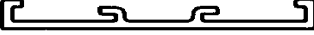

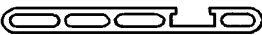





			
E-481 EPDM	E-482 EPDM CEL	E-483 CAU+FLOC	E-484 EPDM
			
E-485 EPDM	E-486 SILICONA	E-487 RG+FL	E-488 SEMI-RIG
			
E-489 EPDM	E-490 EPDM	E-491 POLIETIL	E-492 EPDM
			
E-493 RG+FL	E-494 RG+FL	E-495 POLIC.	E-496 RG
			
E-497 RG	E-498 EPDM	E-499 RG	E-500 RG
			
E-501 EPDM	E-502 EPDM	E-503 EPDM	E-504 EPDM
			
E-505 RG+FL	E-506 FL	E-507 SEMI-RIG	E-508 EPDM
			
E-509 FL	E-510 RG+FL	E-511 FL	E-512 RG+FL

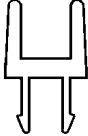



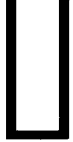

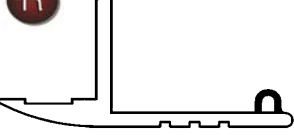
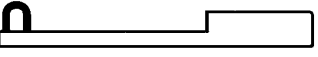

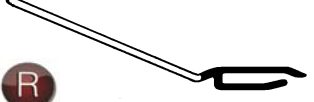





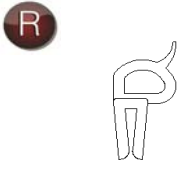

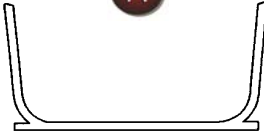

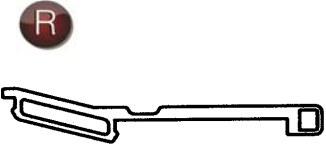

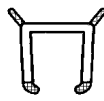
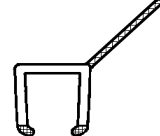
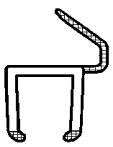
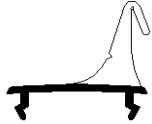
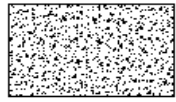



			
E-513 SILICONA	E-514 POLIPRO	E-515 CAUCHO	E-516 SEMI-RIG
			
E-517 FL	E-518 FL+PE	E-519 SILICONA	E-520 RG+FL
			
E-521 RG	E-522 RG+FL	E-523 RG	E-524 EPDM
			
E-525 FL	E-526 RG	E-527 RG	E-528 RG
			
E-529 EPDM	E-530 RG+FL	E-531 RG	E-532 FL
			
E-533 RG+FL	E-534 EPDM	E-535 EPDM	E-536 EPDM
			
E-537 RG+FL	E-538 POLIURET.	E-539 POLIURET.	E-540 EPDM
			
E-541 FL	E-542 RG+FL	E-543 FL	E-544 RG





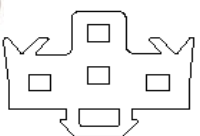



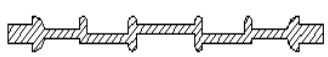
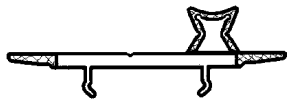



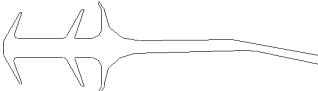

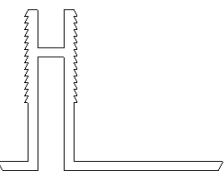

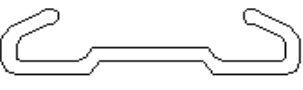

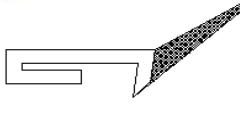







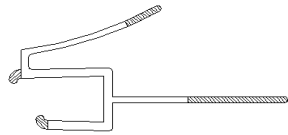



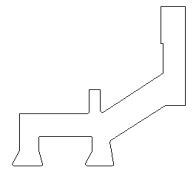

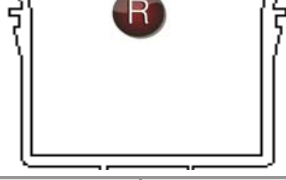
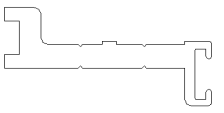
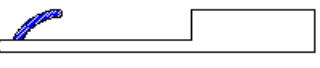
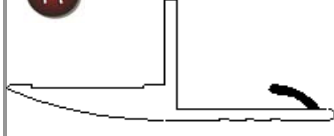



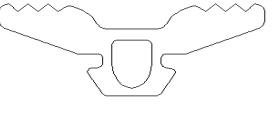

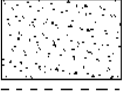





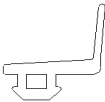

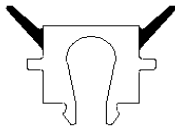

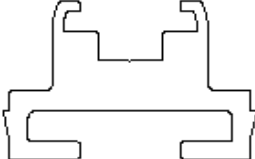

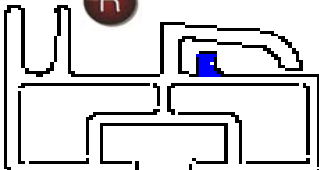





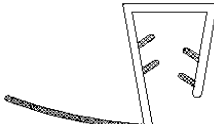

			
E-545 FL	E-546 FL	E-547 RG	E-548 PP+CA
			
E-549 RG+FL	E-550 RG	E-551 PS.ESPAN.	E-552 RG+FL
			
E-553 RG	E-554 RG	E-555 RG	E-556 RG
			
E-557 RG+FL	E-558 EPDM	E-559 EPDM	E-560 POLIES
			
E-561 POLIES	E-562 RG+FL	E-563 RG+FL	E-564 RG
			
E-565 RG	E-566 RG+FL	E-567 RG+FL	E-568 EPDM
			
E-569 RG	E-570 EPDM	E-571 FL	E-572 FL
			
E-573 EPDM	E-574 RG+CA	E-575 FL	E-576 EPDM

			
E-577   EPDM	E-578   FL	E-579   POLIPROP.	E-580   POLIPROP.
			
E-581   FL	E-582   FLEX	E-583   RG+FL	E-584   RG
			
E-585   POLIPROP.	E-586   RG	E-587   RG	E-588   RG
			
E-589   RG+FL	E-590   EPDM	E-591   EPDM	E-592   EPDM
			
E-593   EPDM	E-594   RG	E-595   RG+FL	E-596   EPDM
			
E-597   RG	E-598   FL	E-599   FL	E-600   ABS
			
E-601   RG	E-602   RG+FL	E-603   POLIETIL.	E-604   POLIC.
			
E-605   EPDM	E-606   EPDM	E-607   EPDM	E-608   ESPUM.















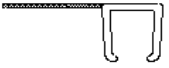
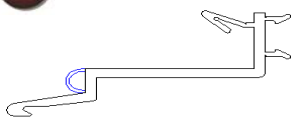
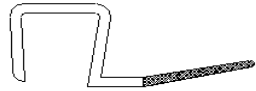
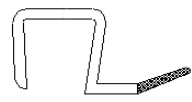
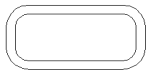







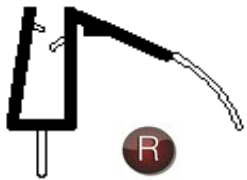

							
E-609	EPDM	E-610	FL	E-611	RG+FL	E-612	FL
							
E-613	EPDM	E-614	RG+FL	E-615	RG+FL	E-616	FL
							
E-617	EPDM	E-618	EPDM	E-619	ABS	E-620	ABS
							
E-621	ABS	E-622	RG+FL	E-623	EPDM	E-624	EPDM
							
E-625	EPDM	E-626	RG+FL	E-627	EPDM ESP.	E-628	EPDM
							
E-629	RG	E-630	EPDM	E-631	EPDM	E-632	SILICONA
							
E-633	FL	E-634	FL	E-635	FL	E-636	FL
							
E-637	ABS+CAU	E-638	ABS+CAU	E-639	RG	E-640	RG+FL

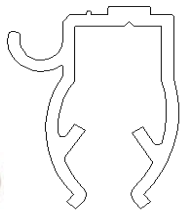
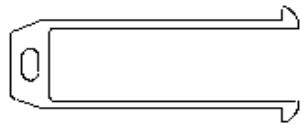





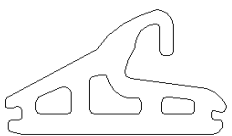





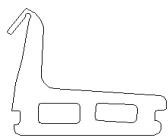
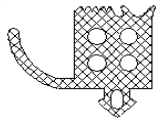
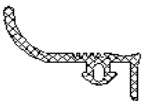
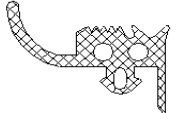
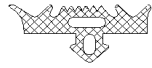







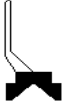

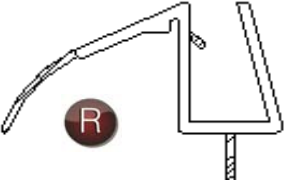
			
E-641	EPDM	E-642	EPDM
			
E-645	PP+CAU	E-646	EPDM
			
E-649	EPDM	E-650	RG
			
E-653	RG+FL	E-654	RG+FL
			
E-657	RG+FL	E-658	RG+FL
			
E-661	PP+CA	E-662	EPDM
			
E-665	EPDM	E-666	EPDM
			
E-669	FL	E-670	EPDM

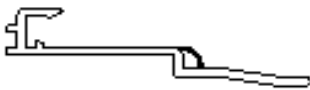

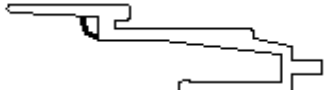
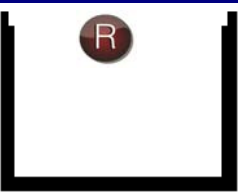



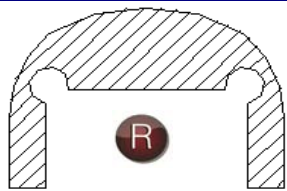
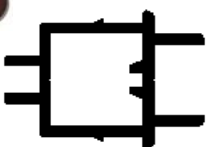



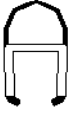





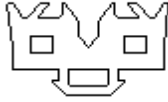
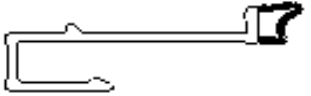

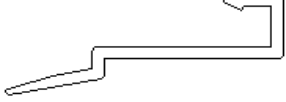

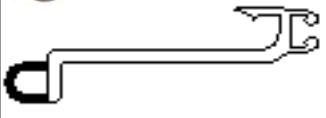



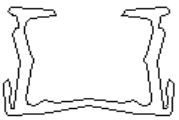

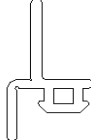
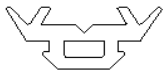
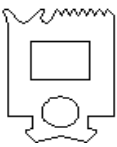

			
E-673   EPDM	E-674   RG+FL	E-675   EPDM	E-676   EPDM
			
E-677   FL	E-678   RIGIDO	E-679   EPDM	E-680   POLIEST.
			
E-681   RG+CA	E-682   RG+FL	E-683   RG+FL	E-684   EPDM
			
E-685   ABS+TPE	E-686   ABS+TPE	E-687   RG+ESPUM	E-688   EPDM CEL
			
E-689   RG+FL	E-690   RG+FL	E-691   RG+FL	E-692   RG
			
E-693   EPDM	E-694   RG+FL	E-695   RG	E-696   EPDM
			
E-697   RG	E-698   RG	E-699   RG+FL	E-700   RG+FL
			
E-701   RG	E-702   EPDM	E-703   EPDM	E-704   EPDM

			
E-705	EPDM CELU	E-706	EPDM CELU
			
E-709	ABS	E-710	ABS+TPE
			
E-713	RG+RG+AD	E-714	RG+FL
			
E-717	POLIEST.	E-718	RG+FL+ADH
			
E-721	RG+FL	E-722	RG+FL
			
E-725	EPDM	E-726	EPDM C.AD
			
E-729	RG+FL	E-730	EPDM
			
E-733	RG+FL	E-734	EPDM
		E-735	EPDM
		E-736	EPDM+CEL

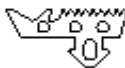









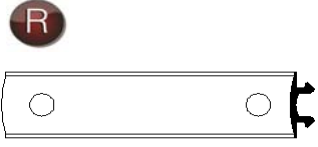
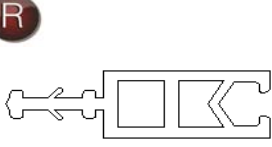
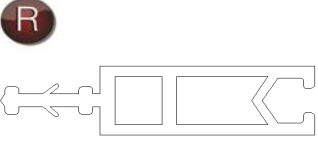
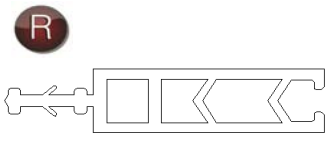

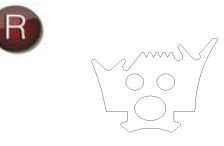
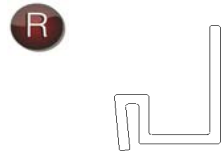

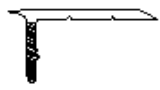
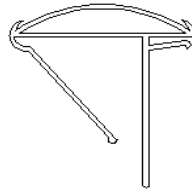

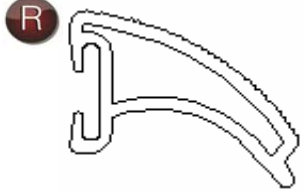



			
E-737 EPDM	E-738 EPDM	E-739 EPDM	E-740 FL+PE
			
E-741 RG+FL	E-742 RG+FL	E-743 RG+FL	E-744 RG+FL
			
E-745 EPDM	E-746 EPDM	E-747 RG	E-748 RG
			
E-749 RG+FL	E-750 RG+FL	E-751 CAUCHO	E-752 RG+FL
			
E-753 RG+FL	E-754 RG+FL	E-755 EPDM	E-756 PBT
			
E-757 EPDM CEL	E-758 POLIC	E-759 FL	E-760 RG+FL
			
E-761 EPDM	E-762 EPDM	E-763 PVC	E-764 RG+FL
			
E-765 EPDM	E-766 EPDM	E-767 EPDM	E-768 RG

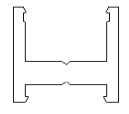

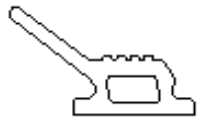
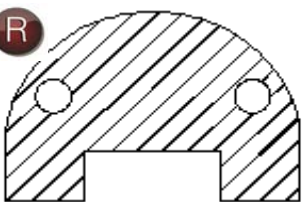
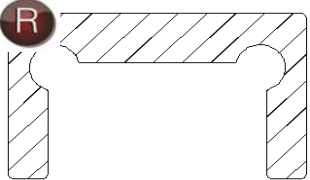
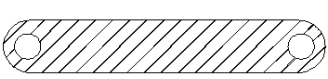



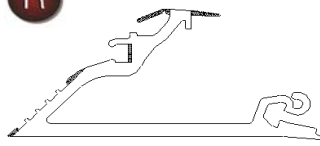
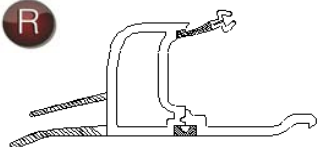



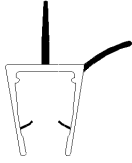

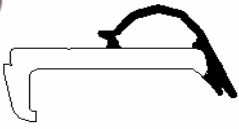
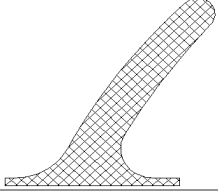
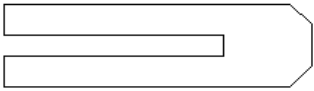

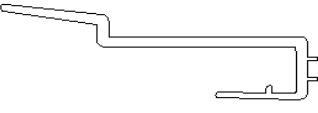
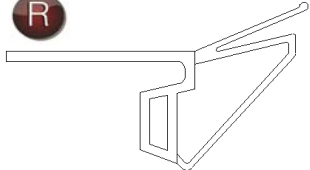

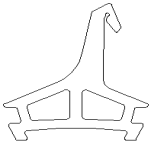

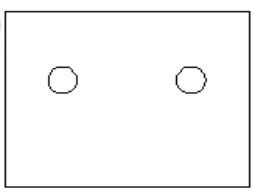
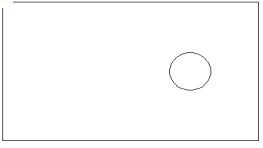

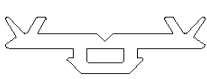
 E-769	RG+FL	 E-770	RG+FL	 E-771	EPDM	 E-772	EPDM
 E-773	EPDM	 E-774	EPDM	 E-775	EPDM	 E-776	EPDM
 E-777	EPDM	 E-778	RG	 E-779	RG	 E-780	RG
 E-781	RG	 E-782	POLIURE.	 E-783	RG+FL	 E-784	R+FL
 E-785	EPDM	 E-786	RG+FL	 E-787	RG+FL	 E-788	RG
 E-789	RG+FL	 E-790	RG	 E-791	RG+FL+ADH	 E-792	RG+FL
 E-793	RG	 E-794	RG	 E-795	RG	 E-796	EPDM
 E-797	EPDM ESP	 E-798	FL	 E-799	RG	 E-800	EPDM



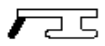

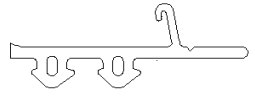
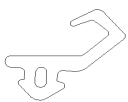
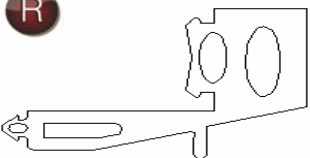
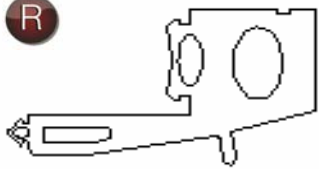
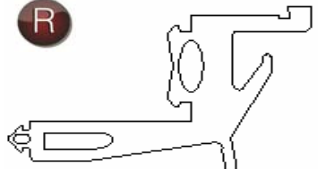
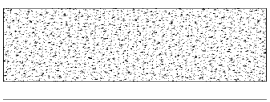

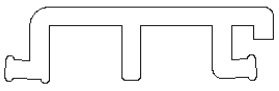







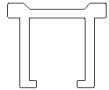



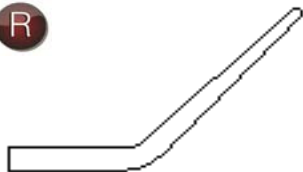

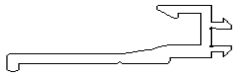
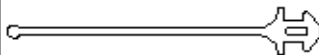
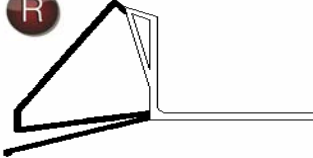
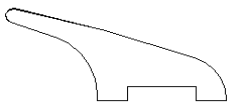

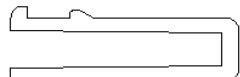

			
E-801	RG+FL	E-802	RG+FL
			
E-805	EPDM	E-806	PP+CAU+FLO
			
E-809	EPDM	E-810	RG
			
E-813	RG	E-814	RG
			
E-817	EPDM	E-818	EPDM
			
E-821	EPDM	E-822	EPDM
			
E-825	EPDM	E-826	EPDM
			
E-829	ABS	E-830	EPDM
		E-831	EPDM
		E-832	EPDM

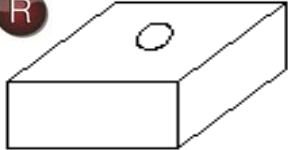
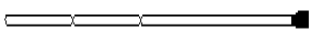



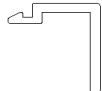
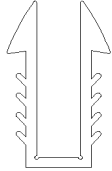





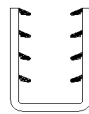

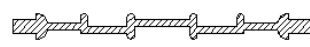

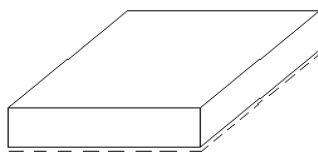











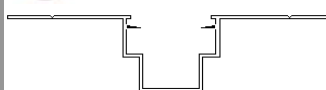
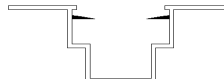
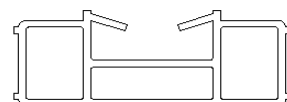

			
E-833   EPDM	E-834   SILICONA	E-835   RG	E-836   RG
			
E-837   GR	E-838   POLIC	E-839   EPDM	E-840   EPDM
			
E-841   EPDM	E-842   RG+FL	E-843   ABS	E-844   EPDM
			
E-845   EPDM	E-846   POLICARB	E-847   RG	E-848   EPDM
			
E-849   POLIURETA	E-850   EPDM	E-851   EPDM	E-852   EPDM
			
E-853   RG	E-854   RG+ FL	E-855   FL	E-856   EPDM
			
E-857   FL	E-858   FL	E-859   FL	E-860   RG
			
E-861   RG	E-862   EPDM	E-833   PP + CAU	E-864   PP + CAU

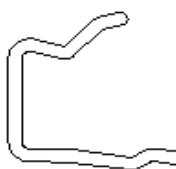

			
E-865 EPDM	E-866 RG+FL	E-867 EPDM CEL	E-868 RG
			
E-869 RG + FL	E-870 FL	E-871 EPDM	E-872 RG + FL
			
E-873 RG	R-874 RG + FL	E-875 FL+PE+HILO	E-876 EPDM
			
E-877 SILICONA	E-878 FL	E-879 FL	E-880 FL+METAL
			
E-881 EPDM	E-882 EPDM	E-883 RG	E-884 RG
			
E-885 RG+FL	E-886 RG+FL	E-887 RG+FL	E-888 EPDM
			
E-889 EPDM	E-890 SILICONA	E-891 SILICONA	E-892 SILICONA
			
E-893 EPDM CEL	E-894 EPDM	E-895 RG	E-896 RG+FL

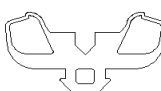
			
E-897	RG+FL	E-898	RG+FL
			
E-901	RG	E-902	EPDM
			
E-905	EPDM	E-906	EPDM
			
E-909	RG	R-911	RG + FL
			
E-913	FL	E-914	RG
			
E-917	RG	E-918	EPDM
			
E-921	RG	E-922	RG+ FL
			
R-925	CAUCHO	E-926	RG + FL

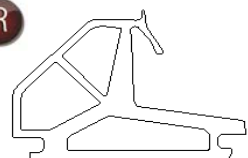











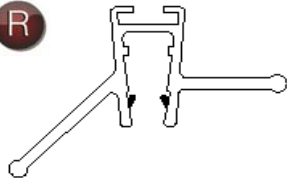

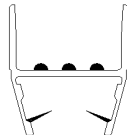

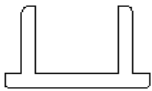
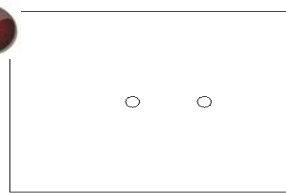
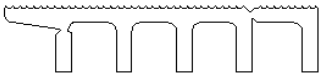
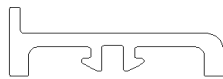

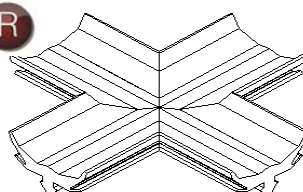

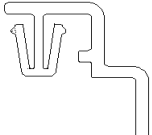
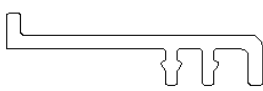
			
E-929   EPDM	E-930   RG + FL	E-931   EPDM	E-932   ABS
			
E-933   RG	E-934   PP CEL ADH	E-935   CAU. ADH	E-936   CAUCHO
			
E-937   FL	E-938   RG+FL	E-939   FL	E-940   SILICONA
			
E-941   RG+FL	E-942   EPDM	E-943   PC. + ADH	E-944   PC. + ADH
			
E-945   EPDM	E-946   RG+FL	E-947   RG+FL	E-948   RG
			
E-949   EPDM	E-950   PP + CAU	R-951   PP + CAU	E-952   PP + CAU
			
E-953   EPDM	E-954   RG	E-955   ABS	E-956   EPDM
			
E-957   EPDM	E-958   EPDM	E-959   EPDM	E-960   EPDM

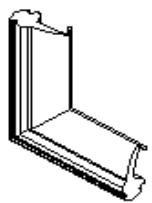
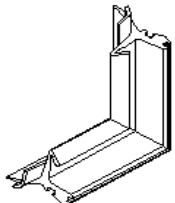
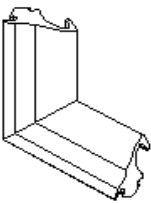
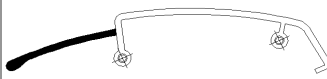

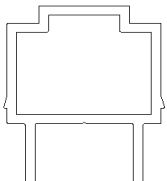
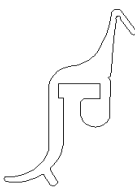







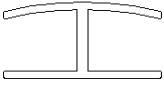

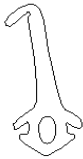
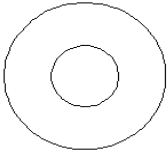
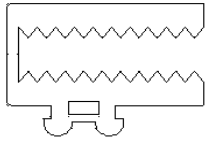
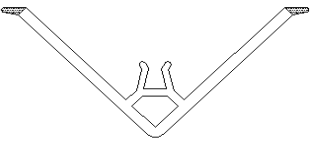
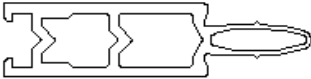
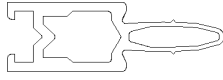

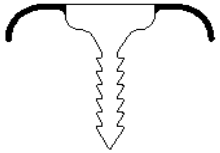
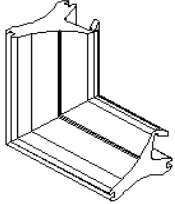
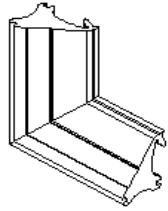
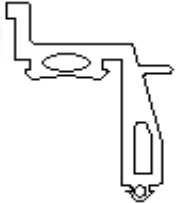
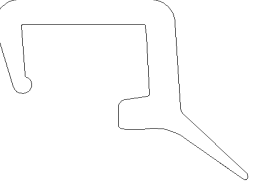
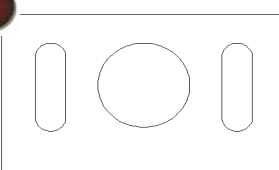
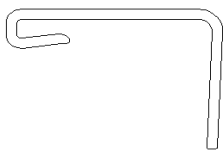





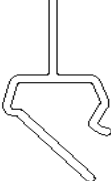



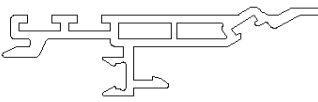
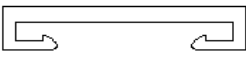

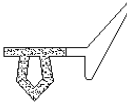
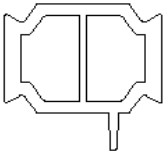

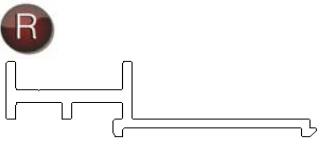

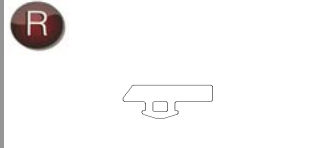
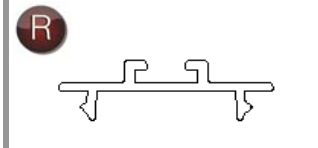
E-961 EPDM	E-962 EPDM	E-963 EPDM	E-964 EPDM
E-965 RG+FL	E-966 RG+FL	E-967 RG	E-968 RG
E-969 RG	E-970 ABS	E-971 RG	E-972 RG
E-973 RG	E-974 RG+RG	E-975 EPDM	E-976 RG+FL
E-977 EPDM	E-978 RG	E-979 RG	E-980 RG+FL
E-981 RG+FL	E-982 RG+FL	E-983 RG+FL	E-984 RG+FL
E-985 RG+FL	E-986 RG+FL	E-987 SEMIRG+FL	E-988 SEMIRG+FL
E-989 RG+FL	E-990 EPDM	E-991 EPDM	E-992 EPDM

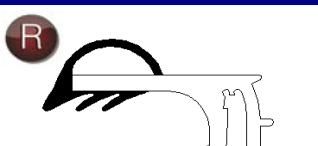

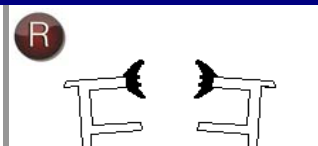
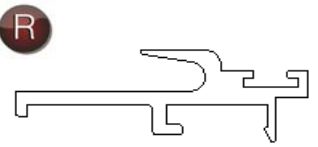

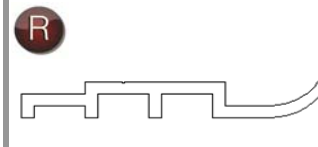
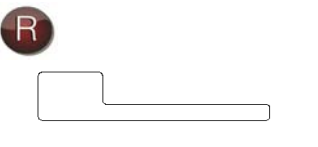
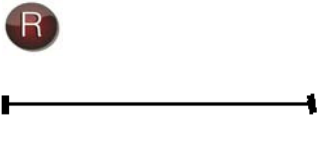
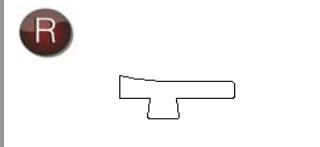
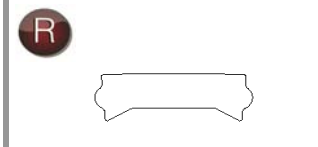

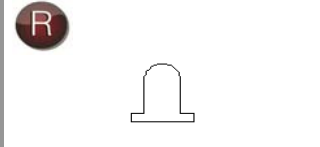
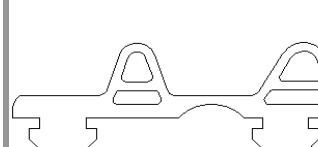
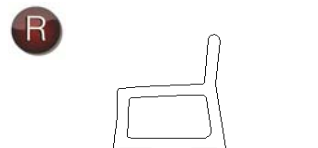
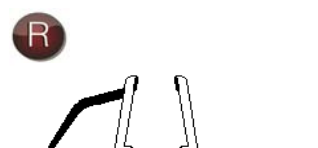
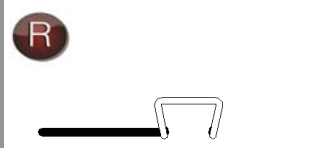
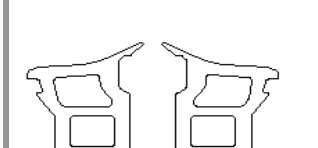
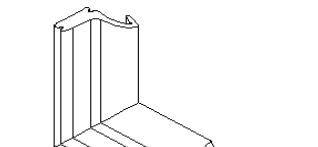
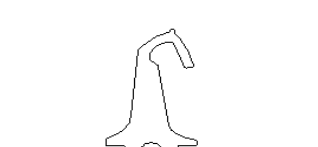
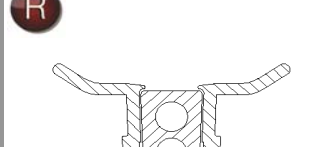
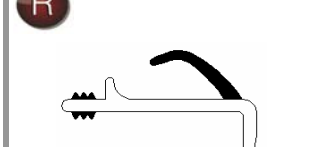
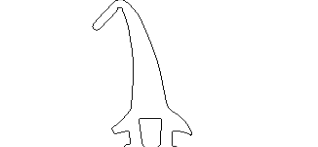

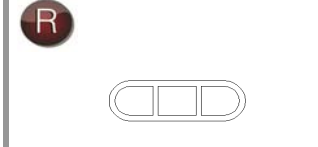



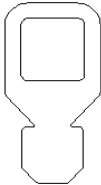





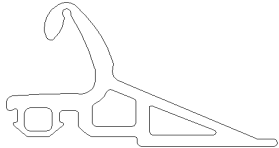
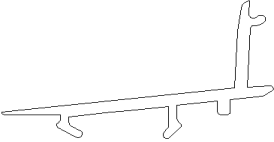
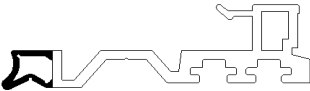
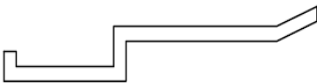



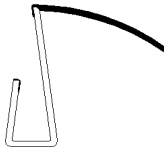

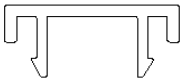

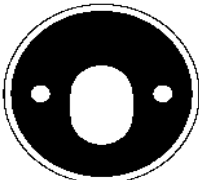

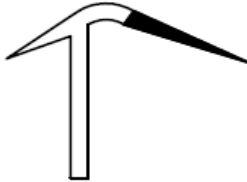
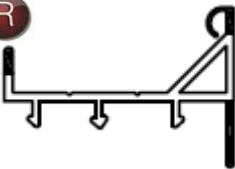

 E-993	EPDM	 E-994	EPDM	 E-995	RG	 E-996	RG+FL
 E-997	RG+FL	 E-998	EPDM	 E-999	RG+FL	 E-1000	RG+FL
 E-1001	EPDM INYEC	 E-1002	EPDM INYEC	 E-1003	RG	 E-1004	RG
 R-1005	EPDM	 R-1006	EPDM	 R-1007	EPDM	 R-1008	EPDM
 E-1009	RG	 E-1010	RG	 E-1011	RG	 E-1012	EPDM
 E-1013	EPDM	 E-1014	EPDM	 E-1015	RG+FL	 E-1016	RG+FL
 E-1017	EPDM	 E-1018	RG	 E-1019	EPDM	 E-1020	EPDM
 E-1021	EPDM	 E-1022	EPDM	 E-1023	EPDM	 E-1024	EPDM













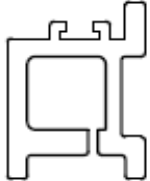





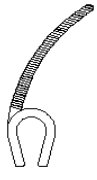





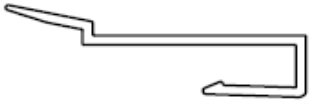

			
E-1025	RG	E-1026	RG + FL
			
E-1029	EPDM	E-1030	RG+FL
			
E-1033	RG	E-1034	RG+FL
			
E-1037	SILICONA	E-1038	EVA
			
E-1041	RG+FL	E-1042	RG+FL
			
E-1045	RG+FL	E-1046	RG
			
E-1049	RG+FL	E-1050	PP+CA+ESP
			
E-1053	RG	E-1054	RG+POLIU

			
E-1057   RG	E-1058   FL + ADH	E-1059   FL	E-1060   RG
			
E-1061   RG+ADH	E-1062   RG+FL	E-1063   RG	E-1064   RG+FL
			
E-1065   RG	E-1066   RG	E-1067   EPDM	E-1068   RG
			
E-1069   EPDM	E-1070   SILICONA	E-1071   EPDM	E-1072   SILICONA
			
E-1073   SILICONA	E-1074   EPDM	E-1075   POLIPROP.	E-1076   EPDM
			
E-1077   EPDM	E-1078   RG+FL	E-1079   RG+FL	E-1080   EPDM
			
E-1081   EPDM	E-1082   EPDM	E-1083   RG	E-1084   RG+FL
			
E-1085   EPDM	E-1086   EPDM	E-1087   EPDM	E-1088   SEMI-RG

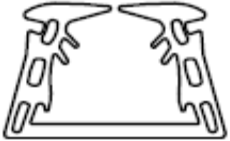

 E-1089	RG	 E-1090	SILICONA	 E-1091	RG	 E-1092	RG+FL
 E-1093	PP+TPE+ESP	 E-1094	RG+FL	 E-1095	RG+FL	 E-1096	EPDM
 E-1097	FL	 E-1098	RG+FL	 E-1099	RG	 E-1100	SEMIRG
 E-1101	RG	 E-1102	RG	 E-1103	RG+FL	 E-1104	RG
 E-1105	RG	 E-1106	RG	 E-1107	CAU+ALU	 E-1108	SEMIRG+FL
 E-1109	EPDM	 E-1110	EPDM	 E-1111	EPDM	 E-1112	RG+FL
 E-1113	RG+FL	 E-1114	FL	 E-1115	Magnético	 E-1116	FL+Magnético
 E-1117	EPDM	 E-1118	EPDM	 E-1119	EPDM	 E-1120	EPDM



			
E-1121   EPDM	E-1122   SILICONA	E-1123   EPDM	E-1124   ABS
			
E-1125   RG+FL	E-1126   RG+FL	E-1127   RG+FL	E-1128   CAU+ESP
			
E-1129   EPDM	E-1130   RG+FL	E-1131   EPDM	E-1132   EPDM
			
E-1133   EPDM	E-1134   EPDM	E-1135   RG+FL	E-1136   RG
			
E-1137   Rg+Fl+Floc	E-1138   FL	E-1139   RG	E-1140   EPDM
			
E-1141   EPDM	E-1142   PE	E-1143   RG	E-1144   EPDM
			
4001   EPDM	4002   SEMIRG	4003   PP+TPO	