

## DIMENSIONES DE PERFILES PARA MAMPARAS DE BAÑO





Figura	Descripción	Figura	Descripción
	<p><b>02.0471.00</b></p> <p>PVC Rígido + flexible Barras (longitud sobre pedido) Perfil U transparente</p> <p>A= 3 B= 5.5 C=5.2</p>		
	<p><b>02.0694.00</b></p> <p>PVC Rígido + flexible Barras (longitud sobre pedido) Perfil U transparente</p> <p>A= 3 B= 7.5 C=6.1</p>		
	<p><b>02.0602.00</b></p> <p>PVC Rígido + flexible Barras (longitud sobre pedido) Perfil U transparente</p> <p>A= 3 B= 19.3 C=7.2</p>		
	<p><b>20.0855.00</b></p> <p>PVC Flexible Barras (longitud sobre pedido) Perfil auxiliar</p> <p>B= 6.3 C= 4.9</p>		

Figura	Descripción	Figura	Descripción
	<p><b>22.0471.00</b></p> <p>PVC Semirigido Barras (longitud sobre pedido) Perfil U transparente</p> <p>A= 4 B= 5.5 C=5.2</p>	<p></p>	<p><b>02.0602.00</b></p> <p>PVC Rígido + flexible Barras (longitud sobre pedido) Perfil U transparente</p> <p>A= 3 B= 19.3 C=7.2</p>
	<p><b>02.0563.00</b></p> <p>PVC Rígido + flexible Barras (longitud sobre pedido) Perfil U transparente</p> <p>A= 4 B= 5.8 C=6.8</p>		
	<p><b>22.0564.00</b></p> <p>PVC Rígido Barras (longitud sobre pedido) Perfil U transparente</p> <p>A= 4 B= 6.8 C=5</p>		
	<p><b>02.0721.00</b></p> <p>PVC Rígido + flexible Barras (longitud sobre pedido) Perfil U transparente</p> <p>A= 4 B= 5.8 C=6.8</p>		
	<p><b>02.0761.00</b></p> <p>PVC Rígido + flexible Barras (longitud sobre pedido) Perfil U transparente</p> <p>A= 4 B= 5.9 C=7.2</p>		
	<p><b>02.0896.00</b></p> <p>PVC Rígido + flexible Barras (longitud sobre pedido) Perfil U transparente</p> <p>A= 4 B= 5.3 C=6.3</p>		



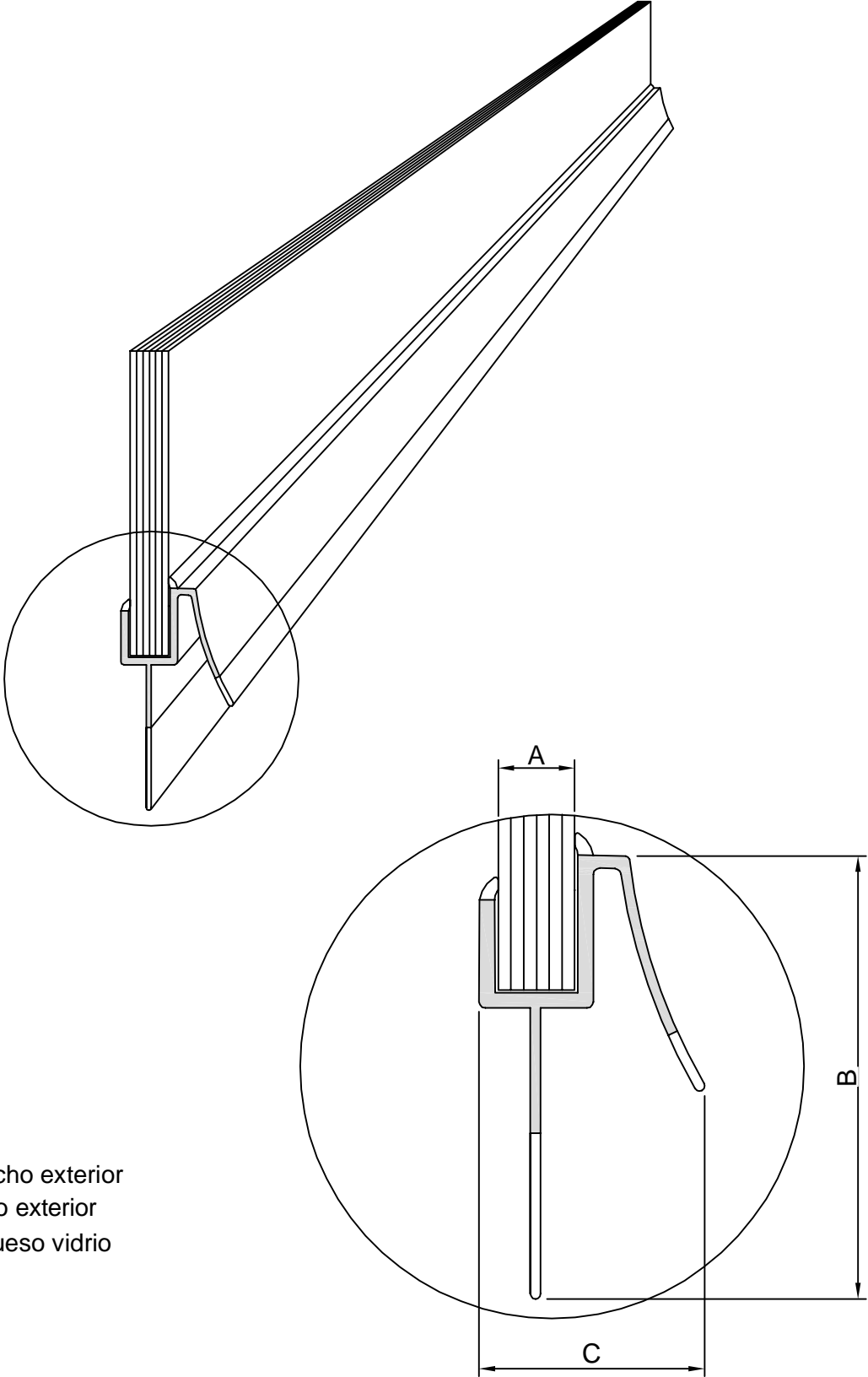

Figura	Descripción	Figura	Descripción
 	<p><b>02.0563.00</b></p> <p>PVC Rígido + flexible Barras (longitud sobre pedido) Perfil U transparente</p> <p>A= 4 B= 5.8 C=6.8</p>	 	<p><b>02.0741.00</b></p> <p>PVC Rígido + flexible Barras (longitud sobre pedido) Perfil U transparente</p> <p>A= 4.5 B= 9.4 C=24</p>
 	<p><b>02.0722.00</b></p> <p>PVC Rígido + flexible Barras (longitud sobre pedido) Perfil U transparente</p> <p>A= 4.5 B= 5 C=6.5</p>	 	<p><b>02.0754.00</b></p> <p>PVC Rígido + flexible Barras (longitud sobre pedido) Perfil U transparente</p> <p>A= 4 B= 25 C=32</p>
	<p><b>02.0651.00</b></p> <p>PVC Rígido + flexible Barras (longitud sobre pedido) Perfil U transparente</p> <p>A= 4.5 B= 11.5 C=12</p>		
 	<p><b>02.0749.00</b></p> <p>PVC Rígido + flexible Barras (longitud sobre pedido) Perfil U transparente</p> <p>A= 3.5 B= 12.5 C=10.5</p>		
	<p><b>02.0653.00</b></p> <p>PVC Rígido + flexible Barras (longitud sobre pedido) Perfil U transparente</p> <p>A= 4.5 B= 16.5 C=11.4</p>		
	<p><b>02.0652.00</b></p> <p>PVC Rígido + flexible Barras (longitud sobre pedido) Perfil U transparente</p> <p>A= 4.5 B= 17.5 C=17</p>		

Figura	Descripción	Figura	Descripción
	<p><b>02.0930.00</b></p> <p>PVC Rígido + flexible Barras (longitud sobre pedido) Perfil U transparente</p> <p>A= 5 B= 14 C=10</p>	<p></p> <p><b>02.0505.00</b></p> <p>PVC Rígido Barras (longitud sobre pedido) Perfil U transparente</p> <p>A= 4 B= 14 C=9.5</p>	
	<p><b>02.0651.00</b></p> <p>PVC Rígido + flexible Barras (longitud sobre pedido) Perfil U transparente</p> <p>A= 4.5 B= 11.5 C=12</p>		<p><b>02.0801.00</b></p> <p>PVC Rígido Barras (longitud sobre pedido) Perfil U transparente</p> <p>A= 4.5 B= 16.5 C=9</p>
	<p><b>02.0731.00</b></p> <p>PVC Rígido + flexible Barras (longitud sobre pedido) Perfil U transparente</p> <p>A= 5 B= 7 C=8.5</p>		<p><b>02.0530.00</b></p> <p>PVC Rígido Barras (longitud sobre pedido) Perfil U transparente</p> <p>A= 6 B= 14.5 C=20</p>
	<p><b>02.0750.00</b></p> <p>PVC Rígido + flexible Barras (longitud sobre pedido) Perfil U transparente</p> <p>A= 4.5 B= 11 C=10</p>		<p><b>02.0611.00</b></p> <p>PVC Rígido Barras (longitud sobre pedido) Perfil U transparente</p> <p>A= 6 B= 14.5 C=27</p>
	<p><b>02.0653.00</b></p> <p>PVC Rígido + flexible Barras (longitud sobre pedido) Perfil U transparente</p> <p>A= 4.5 B= 16.5 C=11.4</p>		<p><b>02.0652.00</b></p> <p>PVC Rígido + flexible Barras (longitud sobre pedido) Perfil U transparente</p> <p>A= 4.5 B= 17.5 C=17</p>
	<p><b>02.0897.00</b></p> <p>PVC Rígido + flexible Barras (longitud sobre pedido) Perfil U transparente</p> <p>A= 4 B= 11 C=8</p>		<p><b>02.0741.00</b></p> <p>PVC Rígido + flexible Barras (longitud sobre pedido) Perfil U transparente</p> <p>A= 4.5 B= 9.4 C=24</p>



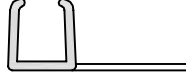

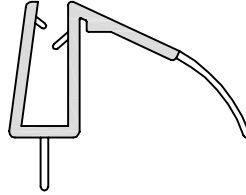
Figura	Descripción	Figura	Descripción
	<p><b>02.0887.00</b></p> <p>PVC Rígido + flexible Barras (longitud sobre pedido) Perfil U transparente</p> <p>A= 4 B= 6 C=25.5</p>		<p><b>02.0376.00</b></p> <p>PVC Rígido + flexible Barras (longitud sobre pedido) Perfil U transparente</p> <p>A= 4.5 B= 32 C=9</p>
	<p><b>02.0731.00</b></p> <p>PVC Rígido + flexible Barras (longitud sobre pedido) Perfil U transparente</p> <p>A= 5.5 B= 24.5 C=11</p>		<p><b>02.0691.00</b></p> <p>PVC Rígido + flexible Barras (longitud sobre pedido) Perfil U transparente</p> <p>A= 4.5 B= 36 C=18</p>
	<p><b>02.0732.00</b></p> <p>PVC Rígido + flexible Barras (longitud sobre pedido) Perfil U transparente</p> <p>A= 5.5 B= 31.5 C=11</p>		<p><b>02.0754.00</b></p> <p>PVC Rígido + flexible Barras (longitud sobre pedido) Perfil U transparente</p> <p>A= 4 B= 25 C=32</p>
	<p><b>02.0039.00</b></p> <p>PVC Rígido + flexible Barras (longitud sobre pedido) Perfil U transparente</p> <p>A= 6 B= 30 C=19</p>		
	<p><b>02.0142.00</b></p> <p>PVC Rígido + flexible Barras (longitud sobre pedido) Perfil U transparente</p> <p>A= 6 B=22 C=20</p>		
	<p><b>02.0327.00</b></p> <p>PVC Rígido + flexible Barras (longitud sobre pedido) Perfil U transparente</p> <p>A= 4.5 B= 24 C=9</p>		

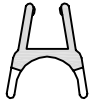
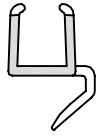
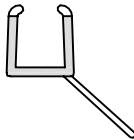



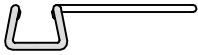

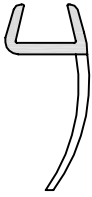
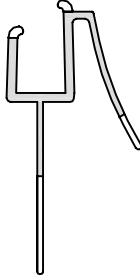
Figura	Descripción	Figura	Descripción
	<p><b>02.0615.00</b></p> <p>PVC Rígido + flexible Barras (longitud sobre pedido) Perfil U transparente</p> <p>A= 5 B= 8 C=11.5</p>	<p></p> <p><b>02.0611.00</b></p> <p>PVC Rígido Barras (longitud sobre pedido) Perfil U transparente</p> <p>A= 6 B= 14.5 C=27</p>	
<p></p> <p><b>02.0750.00</b></p> <p>PVC Rígido + flexible Barras (longitud sobre pedido) Perfil U transparente</p> <p>A= 4.5 B= 11 C=10</p>	<p></p> <p><b>02.0729.00</b></p> <p>PVC Rígido + flexible Barras (longitud sobre pedido) Perfil U transparente</p> <p>A= 5.5 B= 18.5 C=13</p>		
<p></p> <p><b>02.0898.00</b></p> <p>PVC Rígido + flexible Barras (longitud sobre pedido) Perfil U transparente</p> <p>A= 5.8 B= 12.5 C=9.9</p>	<p></p> <p><b>02.0209.00</b></p> <p>PVC Rígido + flexible Barras (longitud sobre pedido) Perfil U transparente</p> <p>A= 9.5 B= 23 C=13</p>		
<p></p> <p><b>02.0493.00</b></p> <p>PVC Rígido + flexible Barras (longitud sobre pedido) Perfil U transparente</p> <p>A= 4.5 B= 20 C=12</p>	<p></p> <p><b>02.0866.00</b></p> <p>PVC Rígido + flexible Barras (longitud sobre pedido) Perfil U transparente</p> <p>A= 6 B= 27 C=20</p>		
<p></p> <p><b>02.0505.00</b></p> <p>PVC Rígido + flexible Barras (longitud sobre pedido) Perfil U transparente</p> <p>A= 4 B= 13.5 C=11</p>	<p></p> <p><b>02.0907.00</b></p> <p>PVC Rígido + flexible Barras (longitud sobre pedido) Perfil U transparente</p> <p>A= 6 B= 27 C=12.5</p>		
<p></p> <p><b>02.0530.00</b></p> <p>PVC Rígido Barras (longitud sobre pedido) Perfil U transparente</p> <p>A= 6 B= 14.5 C=20</p>	<p></p> <p><b>02.0786.00</b></p> <p>PVC Rígido + flexible Barras (longitud sobre pedido) Perfil U transparente</p> <p>A= 6 B= 25 C=36</p>		

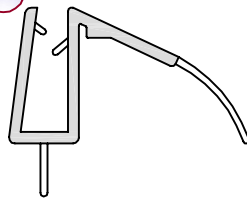
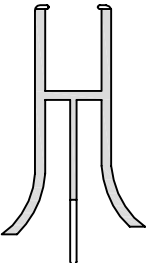
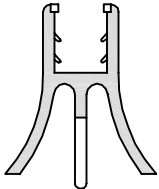
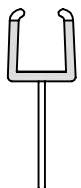

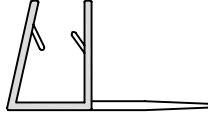

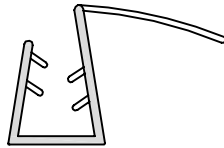

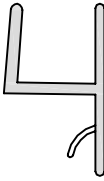
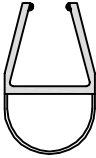
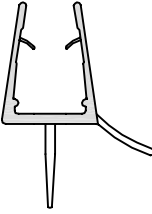
Figura	Descripción	Figura	Descripción
	<p><b>02.0209.00</b></p> <p>PVC Rígido + flexible Barras (longitud sobre pedido) Perfil U transparente</p> <p>A= 9.5 B= 23 C=13</p>		<p><b>02.0744.00</b></p> <p>PVC Rígido + flexible Barras (longitud sobre pedido) Perfil U transparente</p> <p>A= 8 B= 13 C=25</p>
	<p><b>02.0904.00</b></p> <p>PVC Rígido + flexible Barras (longitud sobre pedido) Perfil U transparente</p> <p>A= 8 B= 14 C=12</p>		<p><b>02.0097.00</b></p> <p>PVC Rígido + flexible Barras (longitud sobre pedido) Perfil U transparente</p> <p>A= 7 B= 26 C=13</p>
	<p><b>02.0331.00</b></p> <p>PVC Rígido + flexible Barras (longitud sobre pedido) Perfil U transparente</p> <p>A= 5 B= 16.5 C=13.5</p>		<p><b>02.0866.00</b></p> <p>PVC Rígido + flexible Barras (longitud sobre pedido) Perfil U transparente</p> <p>A= 6 B= 27 C=20</p>
	<p><b>02.0493.00</b></p> <p>PVC Rígido + flexible Barras (longitud sobre pedido) Perfil U transparente</p> <p>A= 4.5 B= 20 C=12</p>		<p><b>02.0907.00</b></p> <p>PVC Rígido + flexible Barras (longitud sobre pedido) Perfil U transparente</p> <p>A= 6 B= 27 C=12.5</p>
	<p><b>02.0729.00</b></p> <p>PVC Rígido + flexible Barras (longitud sobre pedido) Perfil U transparente</p> <p>A= 5.5 B= 18.5 C=13</p>		<p><b>02.0786.00</b></p> <p>PVC Rígido + flexible Barras (longitud sobre pedido) Perfil U transparente</p> <p>A= 6 B= 25 C=36</p>
	<p><b>02.0743.00</b></p> <p>PVC Rígido + flexible Barras (longitud sobre pedido) Perfil U transparente</p> <p>A= 8 B= 13 C=32</p>		

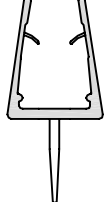
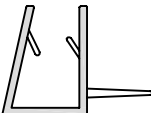
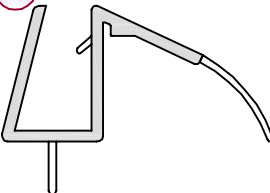

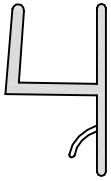
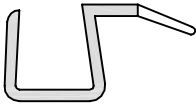
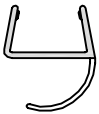
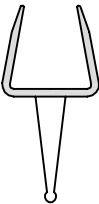
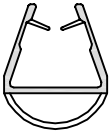
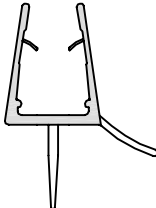
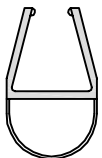
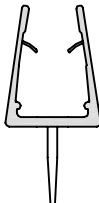
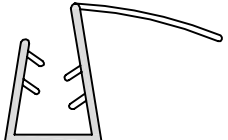
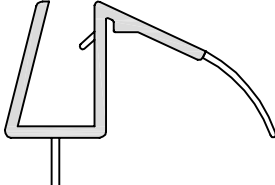
Figura	Descripción	Figura	Descripción
	<p><b>02.4071.00</b></p> <p>PVC Rígido + flexible Barras (longitud sobre pedido) Perfil U transparente</p> <p>A= 10 B= 14 C=14</p>		
	<p><b>02.0331.00</b></p> <p>PVC Rígido + flexible Barras (longitud sobre pedido) Perfil U transparente</p> <p>A= 5 B= 16.5 C=13.5</p>		

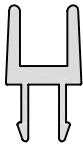
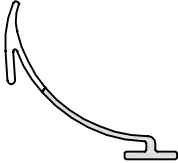
Figura	Descripción	Figura	Descripción
	<p><b>02.0629.00</b></p> <p>PVC Rígido Barras (longitud sobre pedido) Perfil U transparente</p> <p>A= 6 B= 10.5 C=10</p>		
	<p><b>02.4031.00</b></p> <p>PVC Rígido Barras (longitud sobre pedido) Perfil U transparente</p> <p>A= 4 B= 8.5 C=9</p>		
	<p><b>02.4065.00</b></p> <p>PVC Rígido + flexible Barras (longitud sobre pedido) Perfil Estanqueidad transparente</p> <p>A= 7 B=21 C=23</p>		
			<p><b>02.0764.00</b></p> <p>PVC Rígido + flexible Barras (longitud sobre pedido) Perfil U transparente</p> <p>B= 7.2 C=49.9</p>