

DIMENSIONES DE JUNTAS PARA CARPINTERIAS DE ALUMINIO

Dimensiones de juntas de acristalar exterior.  
Opciones: Clipada.

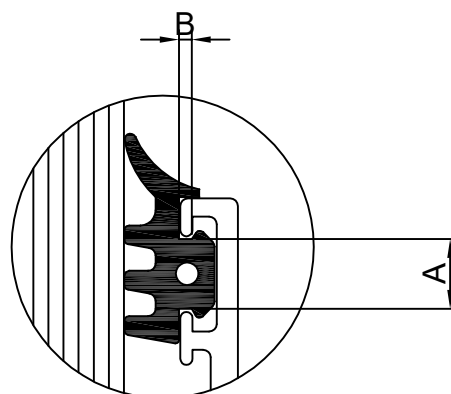

A: Alto cuello de clipaje  
B: Ancho cuello de clipaje

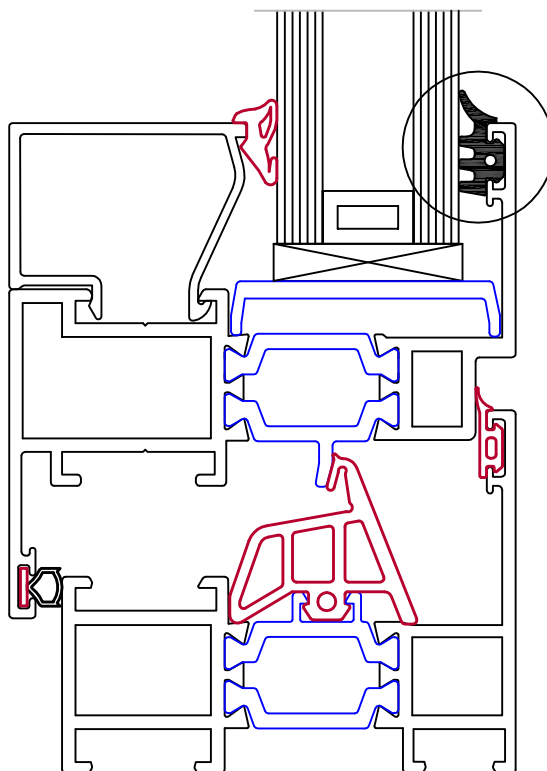













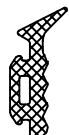
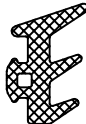

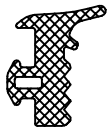



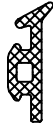

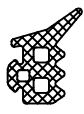
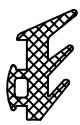
Figura	Descripción	Figura	Descripción
	<b>35.0034.00</b> EPDM Rollos de 200 m. Junta acristalar exterior.  A= 4.1 B= 2.5		<b>35.0141.00</b> EPDM Rollos de 200 m. Junta acristalar exterior.  A= 5.2 B= 1.5
	<b>35.0245.00</b> EPDM Rollos de 200 m. Junta acristalar exterior  A= 4.1 B= 1.2		<b>35.0246.00</b> EPDM Rollos de 200 m. Junta acristalar exterior  A= 1.7 B= 1.2
	<b>35.0264.00</b> EPDM Rollos de 150 m. Junta acristalar exterior.  A= 7.8 B= 1.1		<b>35.0276.00</b> EPDM Rollos de 200 m. Junta acristalar exterior  A= 4.6 B= 1.4
	<b>35.0370.00</b> EPDM Rollos de 200 m. Junta acristalar exterior.  A= 4.7 B= 1		<b>35.0391.00</b> EPDM Rollos de 150 m. Junta acristalar exterior.  A= 4 B= 1.6
	<b>35.0401.00</b> EPDM Rollos de 200 m. Junta acristalar exterior  A= 4.1 B= 2		<b>35.0464.00</b> EPDM Rollos de 250 m. Junta acristalar exterior.  A= 2.8 B= 1.4
	<b>35.1271.00</b> EPDM Rollos de 200 m. Junta acristalar exterior  A=2.3 B=1.2		<b>35.1547.00</b> EPDM Rollos de 200 m. Junta acristalar exterior  A= 4.1 B= 1.2
	<b>35.1957.00</b> EPDM Rollos de 200 m. Junta acristalar exterior  A= 5.9 B= 1.4		<b>35.2382.00</b> EPDM Rollos de 200 m. Junta acristalar exterior  A= 8.2 B=0.4

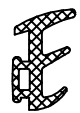
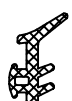
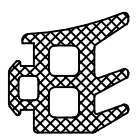
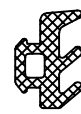
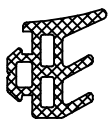
Figura	Descripción	Figura	Descripción
	<b>35.2414.00</b> EPDM Rollos de 200 m. Junta acristalar exterior A= 3.1 B= 0.75		<b>35.2816.00</b> EPDM Rollos de 200 m. Junta acristalar exterior A= 4.8 B= 1.4
	<b>35.3318.00</b> EPDM Rollos de 200 m. Junta acristalar exterior A= 3 B= 1.5		<b>35.3416.00</b> EPDM Rollos de 200 m. Junta acristalar exterior A= 4.8 B= 1.1
	<b>35.3422.00</b> EPDM Rollos de 200 m. Junta acristalar exterior A=3.8 B=1.1		<b>35.3759.00</b> EPDM Rollos de 200 m. Junta acristalar exterior A= 3.1 B= 1.3
	<b>35.4066.00</b> EPDM Rollos de 200 m. Junta acristalar exterior A= 3.6 B= 1.2		<b>35.4073.00</b> EPDM Rollos de 200 m. Junta acristalar exterior A= 5.8 B= 1.7
	<b>35.4074.00</b> EPDM Rollos de 200 m. Junta acristalar exterior A= 5.8 B= 1.7		<b>35.4104.00</b> EPDM Rollos de 200 m. Junta acristalar exterior A= 5.4 B= 1.3
	<b>35.4228.00</b> EPDM Rollos de 200 m. Junta acristalar exterior A= 3 B= 1.4		<b>35.4263.00</b> EPDM Rollos de 200 m. Junta acristalar exterior A= 4 B= 1.5
	<b>35.4336.00</b> EPDM Rollos de 200 m. Junta acristalar exterior A=2 B=1.5		