

DIMENSIONES DE JUNTAS PARA CARPINTERIAS DE ALUMINIO

Dimensiones de juntas marco / hoja exterior
Opciones: Clipada ó guiada

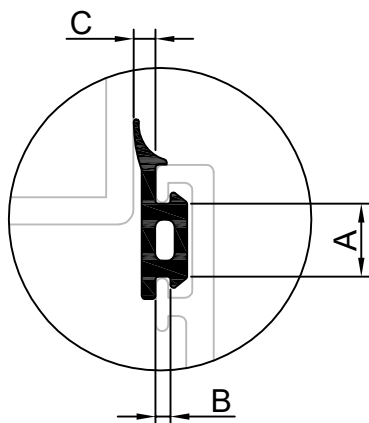

A: Alto cuello de clipaje
B: Ancho cuello de clipaje
C: Grosor de junta

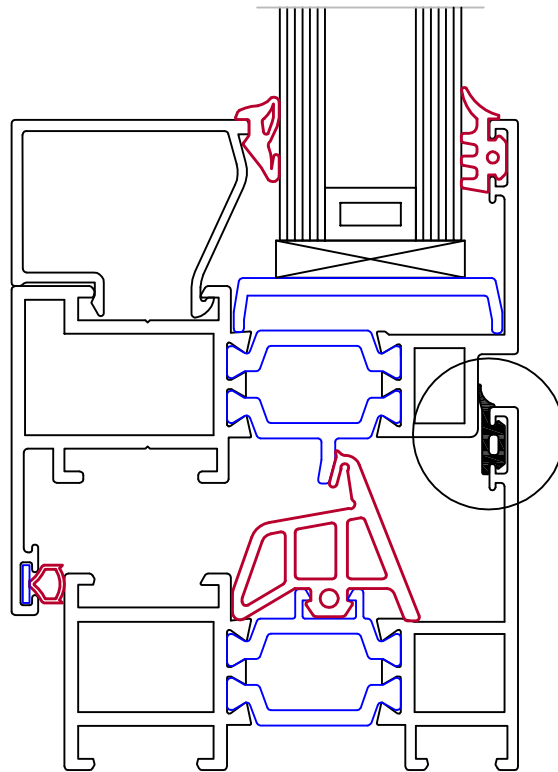
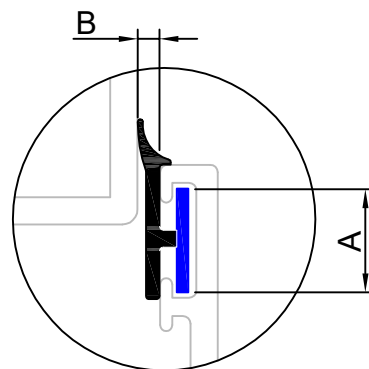

A: Ancho base rígida
B: Grosor de junta







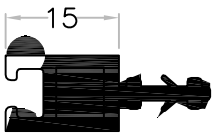
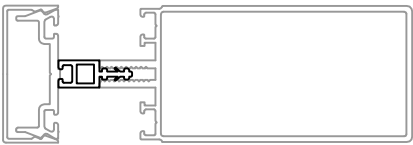
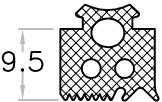
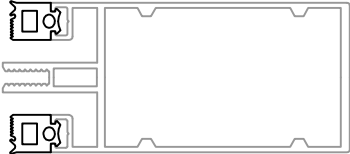
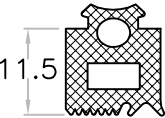
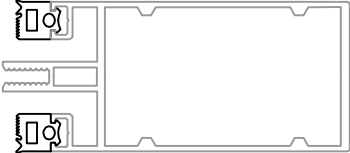
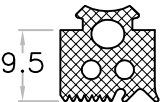
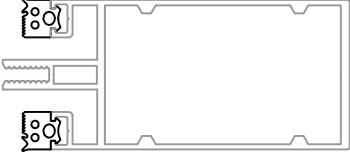
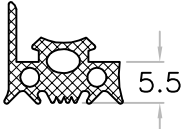
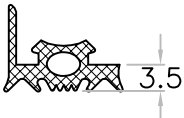
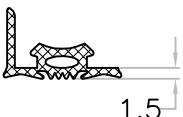
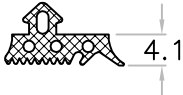
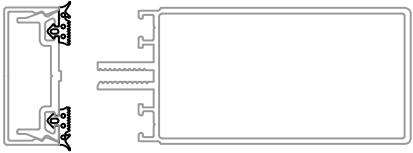
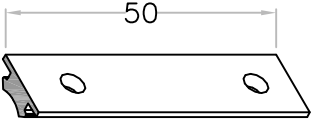

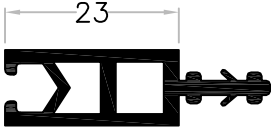
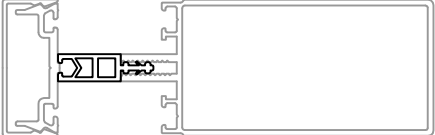
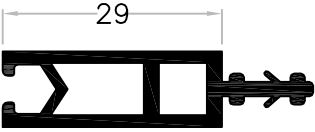
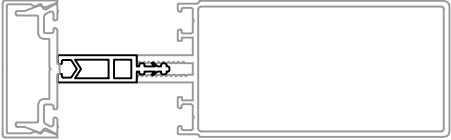
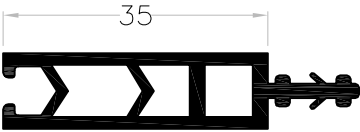
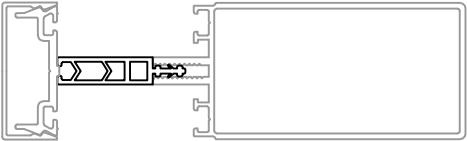
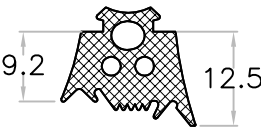
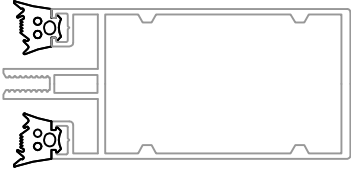
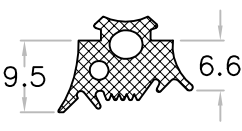
Figura	Descripción	Aplicación
	<p>20.0778.00 PVC Tiras de 6.5 m. Complemento RPT de 15 mm.</p>	
	<p>35.0821.00 EPDM Rollos de 100 m. Junta montante 13.5 mm</p>	
	<p>35.0822.00 EPDM Rollos de 100 m. Junta montante 11.5 mm</p>	
	<p>35.0823.00 EPDM Rollos de 100 m. Junta montante 9.5 mm</p>	
	<p>35.0824.00 EPDM Rollos de 100 m. Junta travesaño 5.5 mm</p>	
	<p>35.0825.00 EPDM Rollos de 100 m. Junta travesaño 3.5 mm</p>	
	<p>35.0826.00 EPDM Rollos de 100 m. Junta travesaño 1.5 mm</p>	

Figura	Descripción	Aplicación
	<p>35.0827.00</p> <p>EPDM</p> <p>Rollos de 100 m.</p> <p>Junta exterior</p>	
	<p>35.0834.00</p> <p>EPDM</p> <p>Pack de 100 uds.</p> <p>Pieza sellado unión travesaño</p>	
	<p>20.0835.00</p> <p>PVC</p> <p>Tiras de 6.5 m.</p> <p>Complemento RPT de 23 mm.</p>	
	<p>20.0836.00</p> <p>PVC</p> <p>Tiras de 6.5 m.</p> <p>Complemento RPT de 29 mm.</p>	
	<p>20.0837.00</p> <p>PVC</p> <p>Tiras de 6.5 m.</p> <p>Complemento RPT de 35 mm.</p>	
	<p>35.0839.00</p> <p>EPDM</p> <p>Rollos de 100 m.</p> <p>Junta poligonal B</p>	
	<p>35.0841.00</p> <p>EPDM</p> <p>Rollos de 100 m.</p> <p>Junta poligonal A</p>	