

DIMENSIONES DE PERFILES DE COMPLEMENTO TÉRMICO PARA CORREDERAS







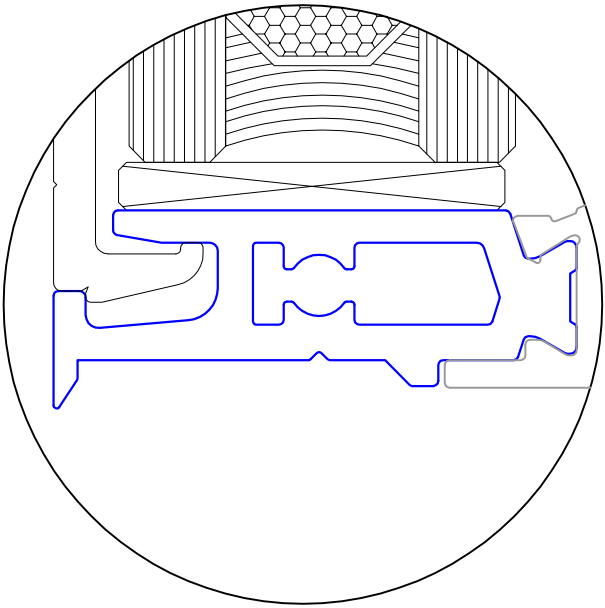
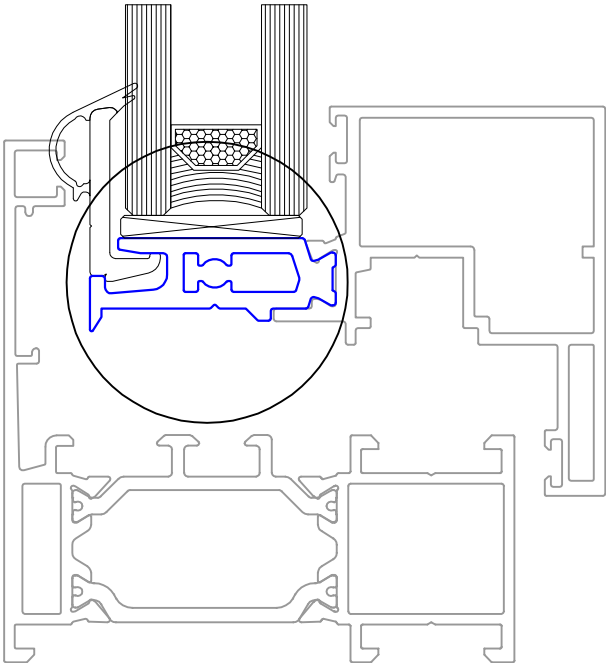

Figura	Descripción	Figura	Descripción
	<p>20.0556.000</p> <p>PVC Rígido</p> <p>Perfil Junquillos RPT.</p>		<p>42.0557.000</p> <p>PVC Rígido/Flexible</p> <p>Perfil Junquillos RPT.</p>
	<p>42.0583.000</p> <p>PVC Rígido/Flexible</p> <p>Perfil Junquillos RPT.</p>		<p>20.0584.000</p> <p>PVC Rígido</p> <p>Perfil Junquillos RPT.</p>
	<p>42.0587.000</p> <p>PVC Rígido/Flexible</p> <p>Perfil Junquillos RPT.</p>		<p>20.0588.000</p> <p>PVC Rígido</p> <p>Perfil Junquillos RPT.</p>
	<p>20.0594.000</p> <p>PVC Rígido</p> <p>Perfil Junquillos RPT.</p>		<p>20.0650.000</p> <p>PVC Rígido</p> <p>Perfil Junquillos RPT.</p>
	<p>20.0658.000</p> <p>PVC Rígido</p> <p>Perfil Junquillos RPT.</p>		<p>20.0659.000</p> <p>PVC Rígido</p> <p>Perfil Junquillos RPT.</p>
	<p>43.0672.000</p> <p>PVC Rígido/Flexible</p> <p>Perfil Junquillos RPT.</p>		<p>42.0689.000</p> <p>PVC Rígido/Flexible</p> <p>Perfil Junquillos RPT.</p>
			<p>42.0690.000</p> <p>PVC Rígido/Flexible</p> <p>Perfil Junquillos RPT.</p>

Figura	Descripción	Figura	Descripción
	20.0692.000 PVC Rígido Perfil Junquillos RPT.		20.0781.000 PVC Rígido Perfil Junquillos RPT.
	42.0792.000 PVC Rígido/Flexible Perfil Junquillos RPT.		20.0793.000 PVC Rígido Perfil Junquillos RPT.
	20.0794.000 PVC Rígido Perfil Junquillos RPT.		20.0795.000 PVC Rígido Perfil Junquillos RPT.
	20.0799.000 PVC Rígido Perfil Junquillos RPT.		42.0808.000 PVC Rígido/Flexible Perfil Junquillos RPT.
	20.0810.000 PVC Rígido Perfil Junquillos RPT.		42.0812.000 PVC Rígido/Flexible Perfil Junquillos RPT.
	20.0813.000 PVC Rígido Perfil Junquillos RPT.		20.0829.000 PVC Rígido Perfil Junquillos RPT.
	20.0840.000 PVC Rígido Perfil Junquillos RPT.		20.0848.000 PVC Rígido Perfil Junquillos RPT.

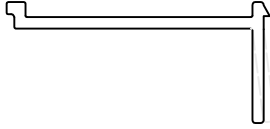
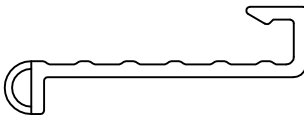
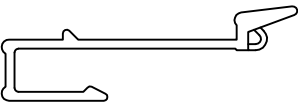

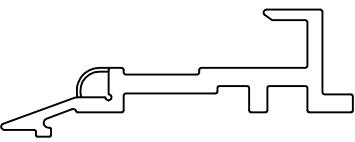

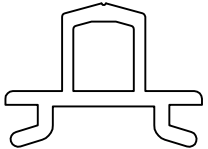

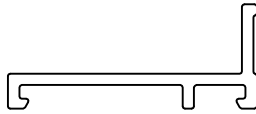
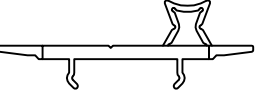
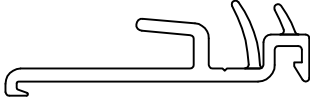
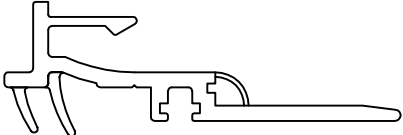
Figura	Descripción	Figura	Descripción
	42.0872.000 PVC Rígido/Flexible Perfil Junquillos RPT.		20.0899.000 PVC Rígido Perfil Junquillos RPT.
	42.0900.000 PVC Rígido/Flexible Perfil Junquillos RPT.		
	20.0901.000 PVC Rígido Perfil Junquillos RPT.		20.0909.000 PVC Rígido Perfil Junquillos RPT.
	20.0920.000 PVC Rígido Perfil Junquillos RPT.		
	20.0921.000 PVC Rígido Perfil Junquillos RPT.		
	20.0933.000 PVC Rígido Perfil Junquillos RPT.		
	43.0941.000 PVC Rígido/Flexible Perfil Junquillos RPT.		75.0955.000 ABS Perfil Junquillos RPT.

Figura	Descripción	Figura	Descripción
			<p>20.0967.000</p> <p>PVC Rígido</p> <p>Perfil Junquillos RPT.</p>
	<p>75.0970.000</p> <p>ABS</p> <p>Perfil Junquillos RPT.</p>		<p>20.0971.000</p> <p>PVC Rígido</p> <p>Perfil Junquillos RPT.</p>
	<p>20.0972.000</p> <p>PVC Rígido</p> <p>Perfil Junquillos RPT.</p>		<p>20.0973.000</p> <p>PVC Rígido</p> <p>Perfil Junquillos RPT.</p>
	<p>20.0978.000</p> <p>PVC Rígido</p> <p>Perfil Junquillos RPT.</p>		<p>20.0995.000</p> <p>PVC Rígido</p> <p>Perfil Junquillos RPT.</p>
	<p>20.1051.000</p> <p>PVC Rígido</p> <p>Perfil Junquillos RPT.</p>		<p>42.1054.000</p> <p>PVC Rígido/Flexible</p> <p>Perfil Junquillos RPT.</p>
			<p>20.1057.000</p> <p>PVC Rígido</p> <p>Perfil Junquillos RPT.</p>
			<p>20.1063.000</p> <p>PVC Rígido</p> <p>Perfil Junquillos RPT.</p>

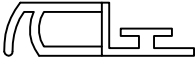

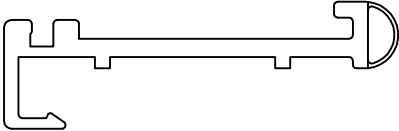
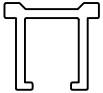
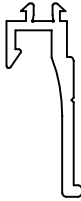

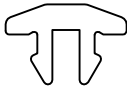
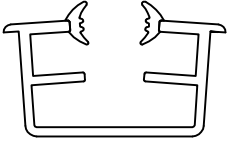
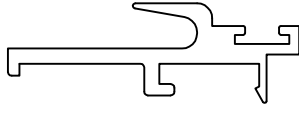
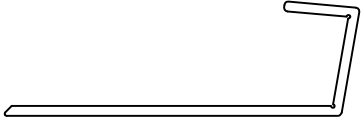
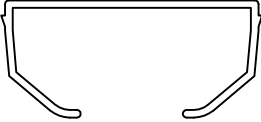
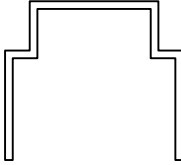
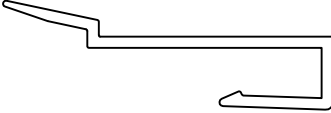
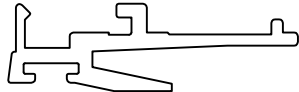
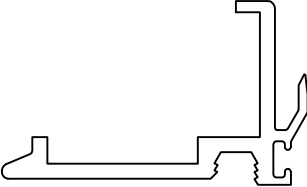
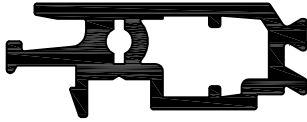
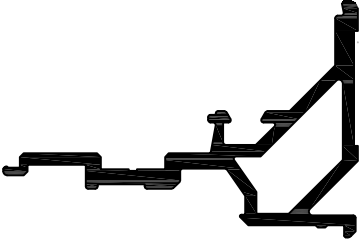
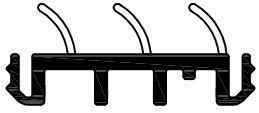

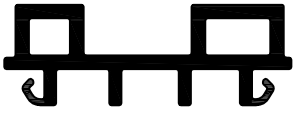
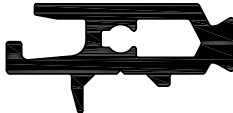
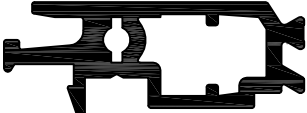
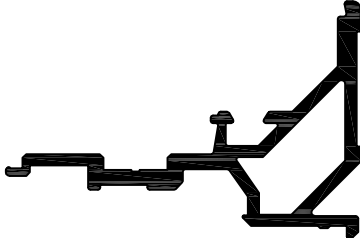
Figura	Descripción	Figura	Descripción
	42.1064.000 PVC Rígido/Flexible Perfil Junquillos RPT.		20.1065.000 PVC Rígido Perfil Junquillos RPT.
			20.1066.000 PVC Rígido Perfil Junquillos RPT.
	20.1091.000 PVC Rígido Perfil Junquillos RPT.		99.1100.000 PVC Semirígido Perfil Junquillos RPT.
	20.1104.000 PVC Rígido Perfil Junquillos RPT.		20.1136.000 PVC Rígido Perfil Junquillos RPT.
	35.4022.000 EPDM Perfil Junquillos RPT.		20.4023.000 PVC Rígido Perfil Junquillos RPT.
	20.4033.000 PVC Rígido Perfil Junquillos RPT.		20.4063.000 PVC Rígido Barras 6500 mm. Perfil U de marco. A= 9.3 B= 18.5
			20.4064.000 PVC Rígido Barras 6500 mm. Perfil U de marco. A= 4 B= 31.3 C= 46.9

Figura	Descripción	Figura	Descripción
	<p>42.6131.000</p> <p>PVC Rígido Barras 6500 mm. Perfil U de marco.</p> <p>A= 32.7 B= 13.3 C= 00</p>		<p>20.6132.000</p> <p>PVC Rígido Barras 6500 mm. Perfil U de marco.</p> <p>A= 33.2 B= 10.5 C= 11.8</p>
	<p>20.6133.000</p> <p>PVC Rígido Barras 6500 mm. Perfil U de marco.</p> <p>A= 38 B= 13.3 C= 14.3</p>		<p>20.6051.000</p> <p>PVC Rígido Barras 6500 mm. Perfil U de marco.</p> <p>A= 30.2 B= 9.3 C= 5.2</p>
	<p>20.4063.000</p> <p>PVC Rígido Barras 6500 mm. Perfil U de marco.</p> <p>A= 9.3 B= 18.5</p>		<p>20.4063.000</p> <p>PVC Rígido Barras 6500 mm. Perfil U de marco.</p> <p>A= 9.3 B= 18.5</p>